

### FEATURES

- Double Side Cooling
- Reverse Blocking Capability
- High Reliability In Service
- High Voltage Capability
- Fault Protection Without Fuses
- High Surge Current Capability
- Turn-off Capability Allows Reduction In Equipment Size And Weight. Low Noise Emission Reduces Acoustic Cladding Necessary For Environmental Requirements

### APPLICATIONS

- Variable speed A.C. motor drive inverters (VSD-AC)
- Uninterruptable Power Supplies
- High Voltage Converters
- Choppers
- Welding
- Induction Heating
- DC/DC Converters

### KEY PARAMETERS

$I_{TCM}$	<b>700A</b>
$V_{DRM}$	<b>1800V</b>
$I_{T(AV)}$	<b>240A</b>
$dV_D/dt$	<b>500V/μs</b>
$di_T/dt$	<b>500A/μs</b>

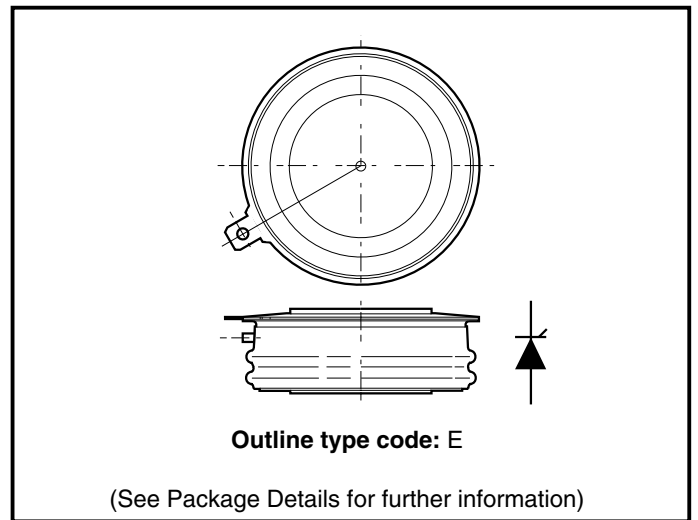

Fig. 1 Package outline

### VOLTAGE RATINGS

Type Number	Repetitive Peak Off-state Voltage $V_{DRM}$ V	Repetitive Peak Reverse Voltage $V_{RRM}$ V	Conditions
DGT305SE18	1800	1800	$T_{vj} = 125^{\circ}C$ , $I_{DM} = 50mA$ , $I_{RRM} = 50mA$ , $V_{RG} = 2V$

### CURRENT RATINGS

Symbol	Parameter	Conditions	Max.	Units
$I_{TCM}$	Repetitive peak controllable on-state current	$V_D = 67\%V_{DRM}$ , $T_j = 125^{\circ}C$ , $di_{GO}/dt = 15A/\mu s$ , $C_s = 1.5\mu F$	700	A
$I_{T(AV)}$	Mean on-state current	$T_{HS} = 80^{\circ}C$ . Double side cooled. Half sine 50Hz.	240	A
$I_{T(RMS)}$	RMS on-state current	$T_{HS} = 80^{\circ}C$ . Double side cooled. Half sine 50Hz.	373	A

## SURGE RATINGS

Symbol	Parameter	Conditions	Max.	Units
$I_{TSM}$	Surge (non-repetitive) on-state current	10ms half sine. $T_j = 125^\circ\text{C}$	4.0	kA
$I^2t$	$I^2t$ for fusing	10ms half sine. $T_j = 125^\circ\text{C}$	80000	$\text{A}^2\text{s}$
$di_T/dt$	Critical rate of rise of on-state current	$V_D = 67\% V_{DRM}$ , $I_T = 700\text{A}$ , $T_j = 125^\circ\text{C}$ , $I_{FG} > 20\text{A}$ , Rise time $< 1.0\mu\text{s}$	500	$\text{A}/\mu\text{s}$
$dV_D/dt$	Rate of rise of off-state voltage	To 80% $V_{DRM}$ ; $R_{GK} \leq 1.5\Omega$ , $T_j = 125^\circ\text{C}$	500	$\text{V}/\mu\text{s}$
$V_{DP}$	Peak forward transient voltage during current fall time	$V_D = 67\% V_{DRM}$ , $I_T = 700\text{A}$ , $T_j = 125^\circ\text{C}$ , $di_{GQ}/dt = 15\text{A}/\mu\text{s}$ , $C_s = 1.5\mu\text{F}$	400	V

## GATE RATINGS

Symbol	Parameter	Conditions	Min.	Max.	Units
$V_{RGM}$	Peak reverse gate voltage	This value maybe exceeded during turn-off	-	16	V
$I_{FGM}$	Peak forward gate current		-	50	A
$P_{FG(AV)}$	Average forward gate power		-	10	W
$P_{RGM}$	Peak reverse gate power		-	6	kW
$di_{GQ}/dt$	Rate of rise of reverse gate current		10	50	$\text{A}/\mu\text{s}$
$t_{ON(min)}$	Minimum permissible on time		20	-	$\mu\text{s}$
$t_{OFF(min)}$	Minimum permissible off time		40	-	$\mu\text{s}$

## THERMAL RATINGS

Symbol	Parameter	Conditions	Min.	Max.	Units	
$R_{th(j-hs)}$	DC thermal resistance - junction to heatsink surface	Double side cooled	-	0.075	$^\circ\text{C}/\text{W}$	
		Anode side cooled	-	0.12	$^\circ\text{C}/\text{W}$	
		Cathode side cooled	-	0.20	$^\circ\text{C}/\text{W}$	
$R_{th(c-hs)}$	Contact thermal resistance	Clamping force 5.5kN With mounting compound	per contact	-	0.018	$^\circ\text{C}/\text{W}$
$T_{vj}$	Virtual junction temperature		-	125	$^\circ\text{C}$	
$T_{OP}/T_{stg}$	Operating junction/storage temperature range		-40	125	$^\circ\text{C}$	
-	Clamping force		5.0	6.0	kN	

**CHARACTERISTICS**

<b>T<sub>j</sub> = 125°C unless stated otherwise</b>					
<b>Symbol</b>	<b>Parameter</b>	<b>Conditions</b>	<b>Min.</b>	<b>Max.</b>	<b>Units</b>
V <sub>TM</sub>	On-state voltage	At 600A peak, I <sub>G(ON)</sub> = 2A d.c.	-	2.5	V
I <sub>DM</sub>	Peak off-state current	At V <sub>DRM</sub> , V <sub>RG</sub> = 2V	-	50	mA
I <sub>RRM</sub>	Peak reverse current	At V <sub>RRM</sub>	-	50	mA
V <sub>GT</sub>	Gate trigger voltage	V <sub>D</sub> = 24V, I <sub>T</sub> = 100A, T <sub>j</sub> = 25°C	-	0.75	V
I <sub>GT</sub>	Gate trigger current	V <sub>D</sub> = 24V, I <sub>T</sub> = 100A, T <sub>j</sub> = 25°C	-	1.2	A
I <sub>RGM</sub>	Reverse gate cathode current	V <sub>RGM</sub> = 16V, No gate/cathode resistor	-	50	mA
E <sub>ON</sub>	Turn-on energy	V <sub>D</sub> = 1200V, I <sub>T</sub> = 600A,	-	160	mJ
t <sub>d</sub>	Delay time	I <sub>FG</sub> = 20A, rise time < 1.0μs	-	1.1	μs
t <sub>r</sub>	Rise time	R <sub>L</sub> = (Residual inductance 2.75μH)	-	2.5	μs
E <sub>OFF</sub>	Turn-off energy	I <sub>T</sub> = 600A, V <sub>D</sub> = 1200V, Snubber Cap Cs = 1.5μF, di <sub>GQ</sub> /dt = 15A/μs R <sub>L</sub> = (Residual inductance 2.75μH)	-	550	mJ
t <sub>tail</sub>	Tail time		-	30	μs
t <sub>gs</sub>	Storage time		-	12	μs
t <sub>gf</sub>	Fall time		-	1.5	μs
t <sub>gq</sub>	Gate controlled turn-off time		-	13.5	μs
Q <sub>GQ</sub>	Turn-off gate charge		-	900	μC
Q <sub>GQT</sub>	Total turn-off gate charge		-	1800	μC

CURVES

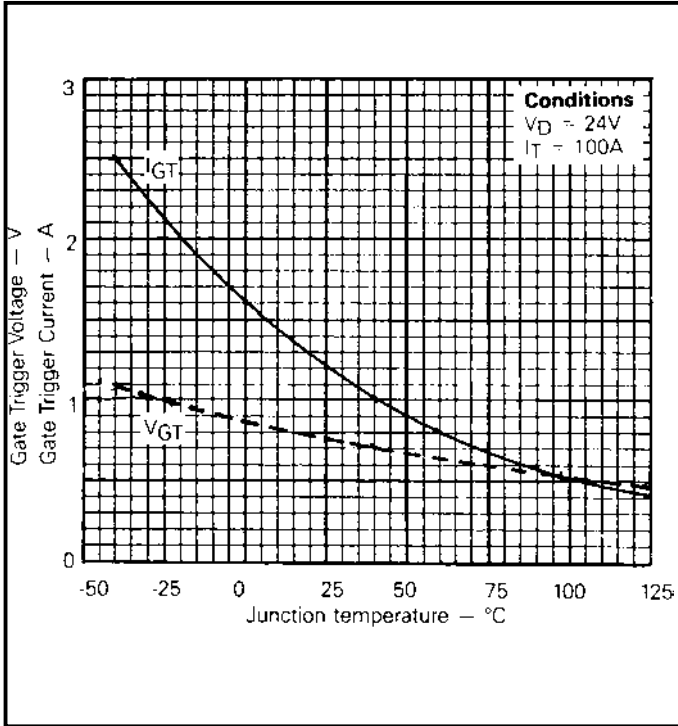

Fig.2 Gate characteristics

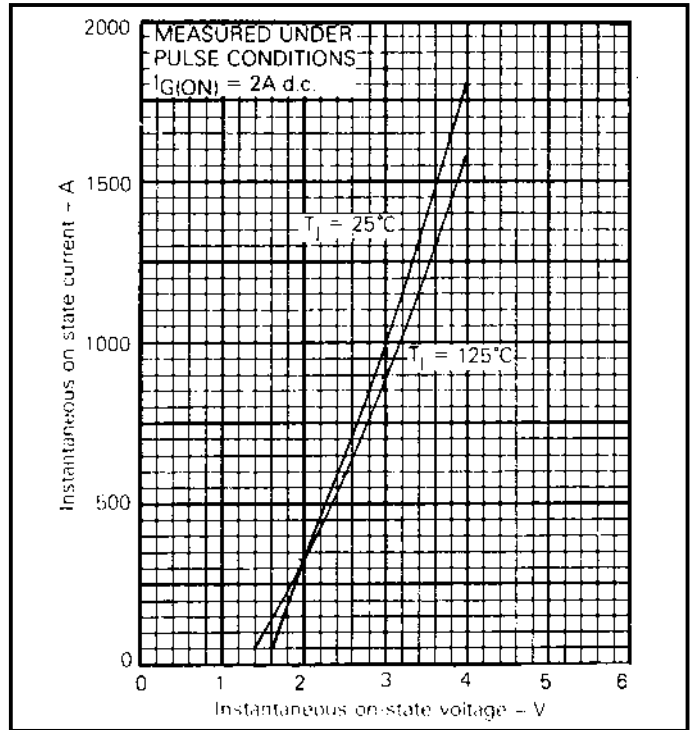

Fig.3 Maximum (limit) on-state characteristics

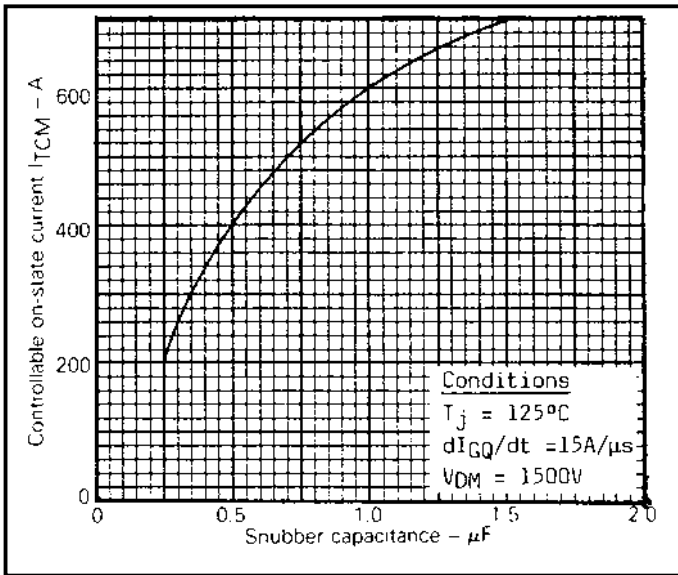

Fig.4 Dependence of  $I_{TCM}$  on  $C_s$

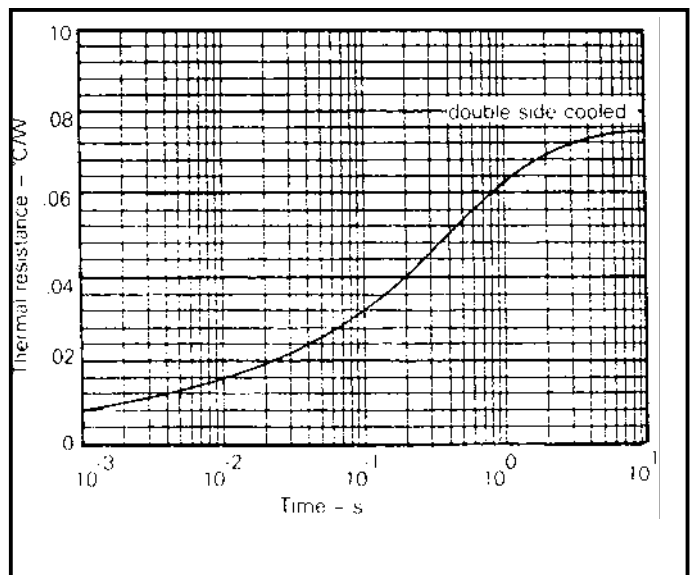
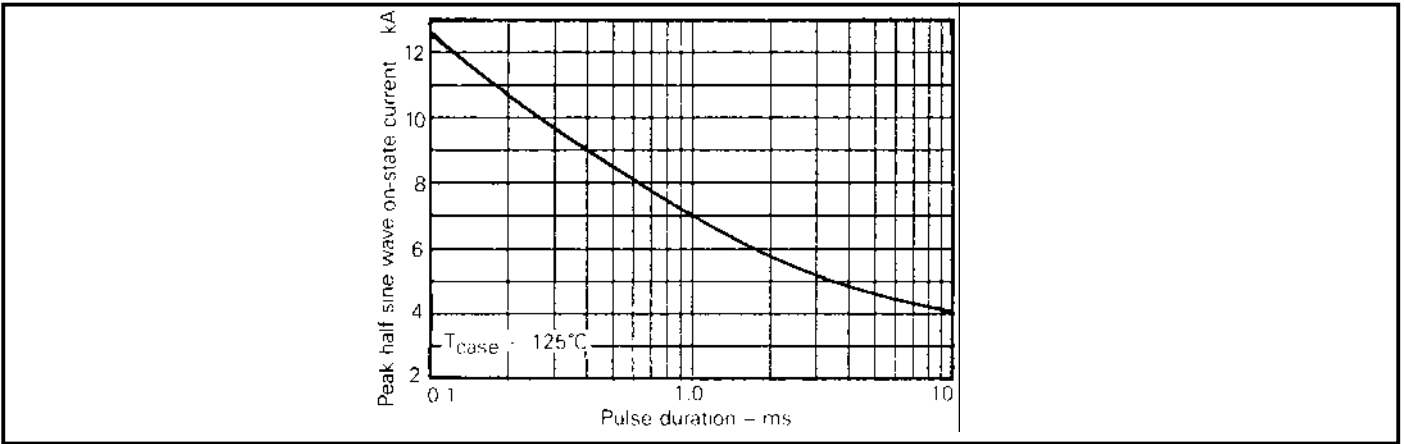
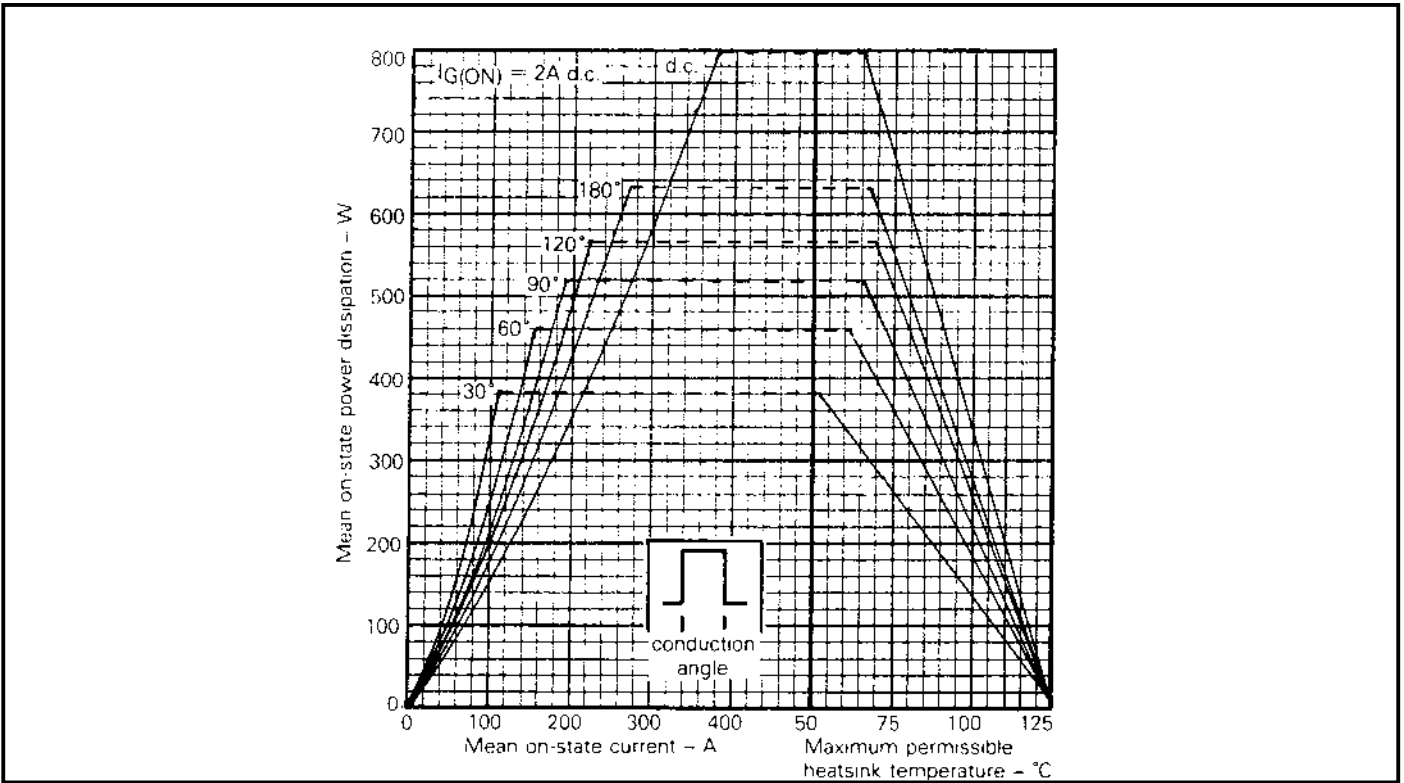

Fig.5 Maximum (limit) transient thermal resistance



**Fig.6 Surge (non-repetitive) on-state current vs time**



**Fig.7 Steady state rectangular wave conduction loss - double side cooled**

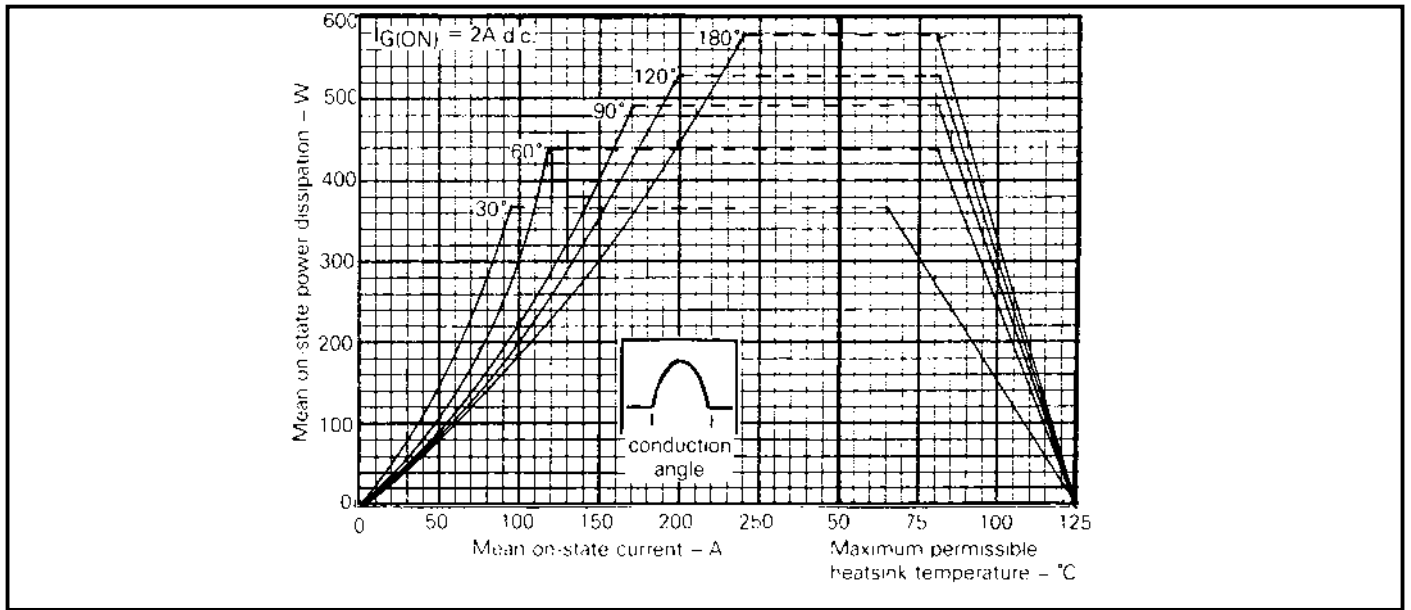

Fig.8 Steady state sinusoidal wave conduction loss - double side cooled

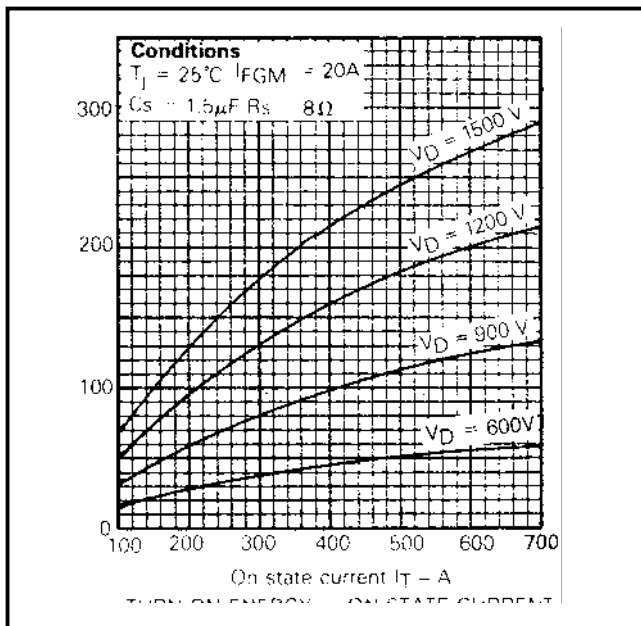

Fig.9 Turn-on energy vs on-state current

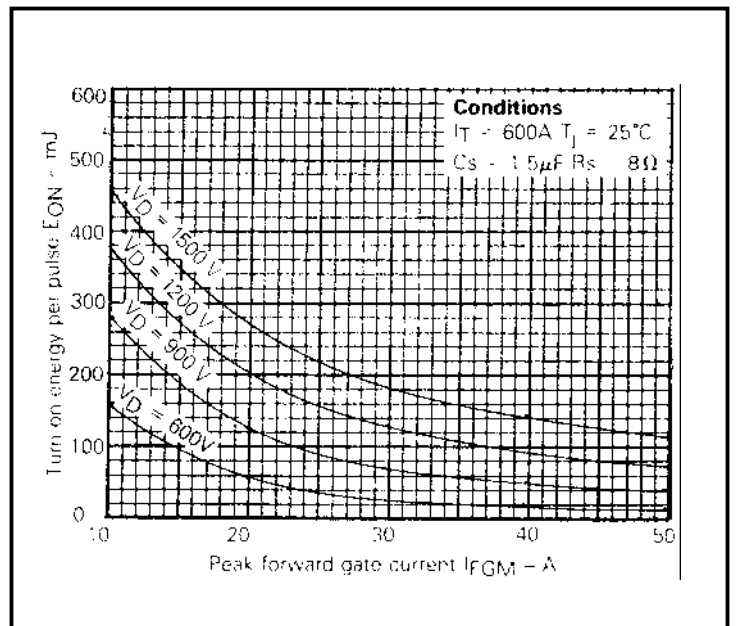
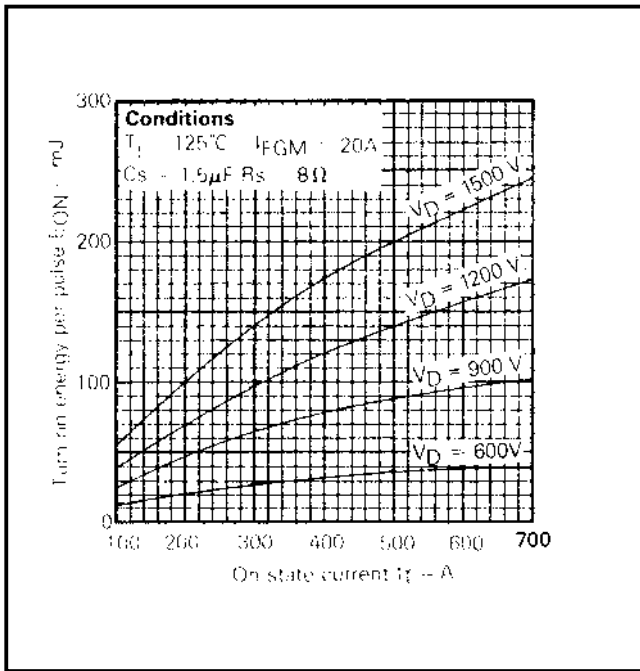
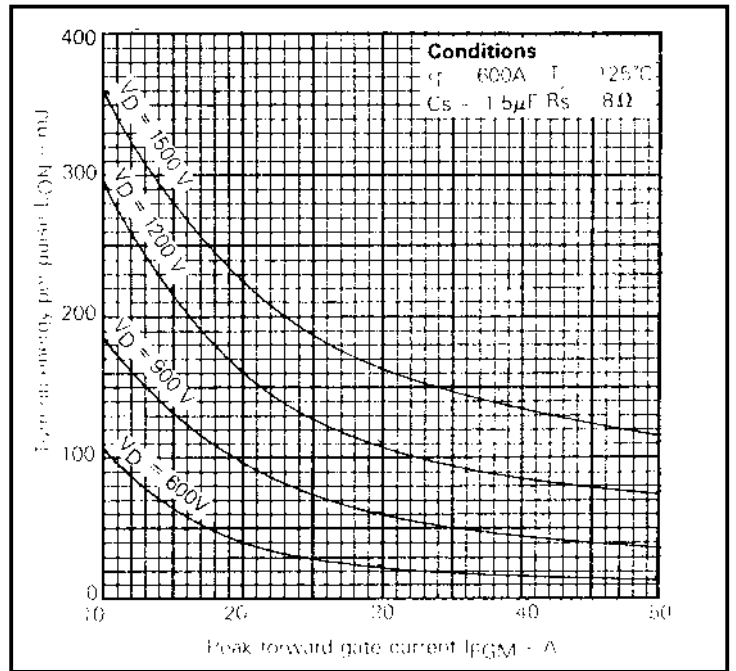

Fig.10 Turn-on energy vs peak forward gate current



**Fig.11 Turn-on energy vs on-state current**



**Fig.12 Turn-on energy vs peak forward gate current**

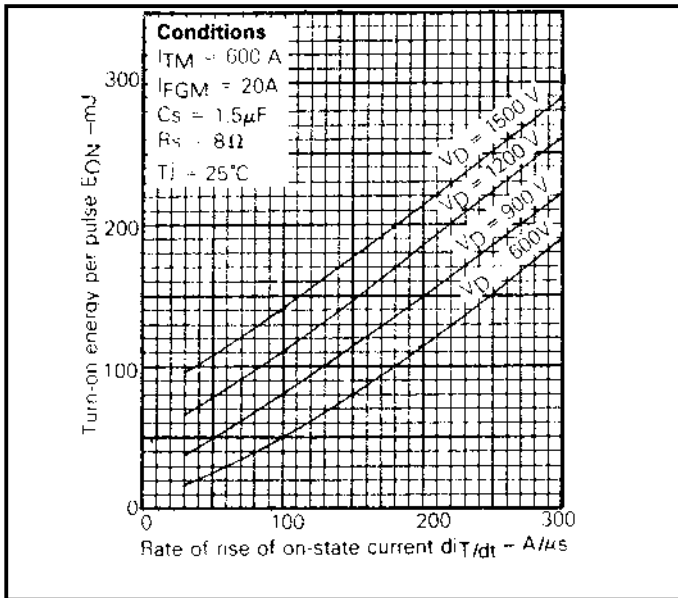

**Fig.13 Turn-on energy vs rate of rise of on-state current**

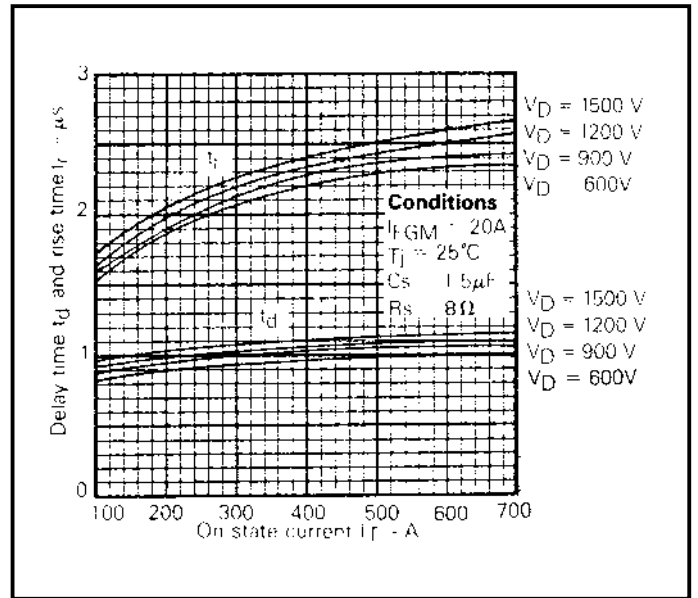

**Fig.14 Delay time and rise time vs on-state current**

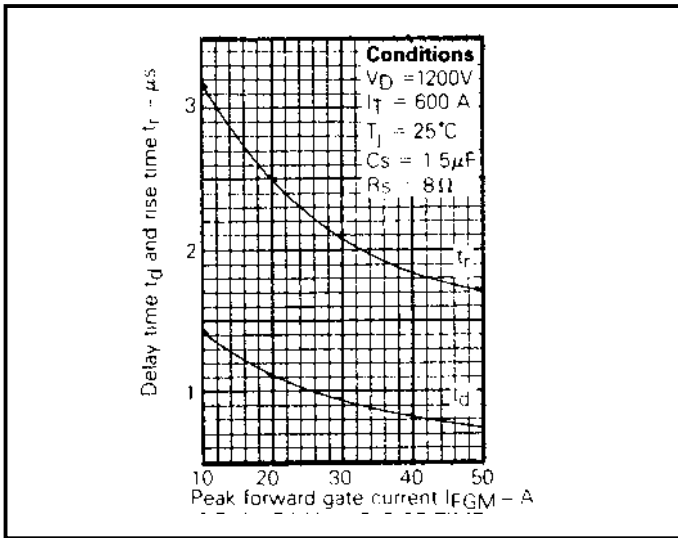

Fig.15 Delay time and rise time vs peak forward gate current

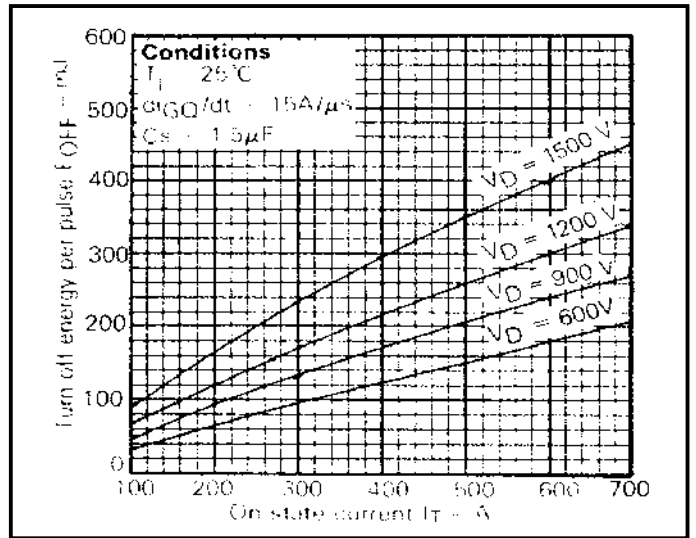

Fig.16 Turn-off energy vs on-state current

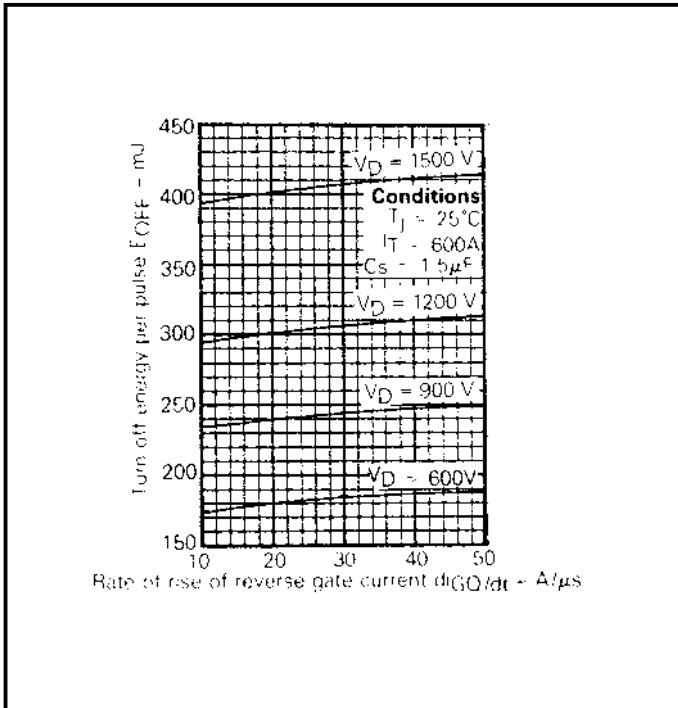

Fig.17 Turn-off energy vs rate of rise of reverse gate current

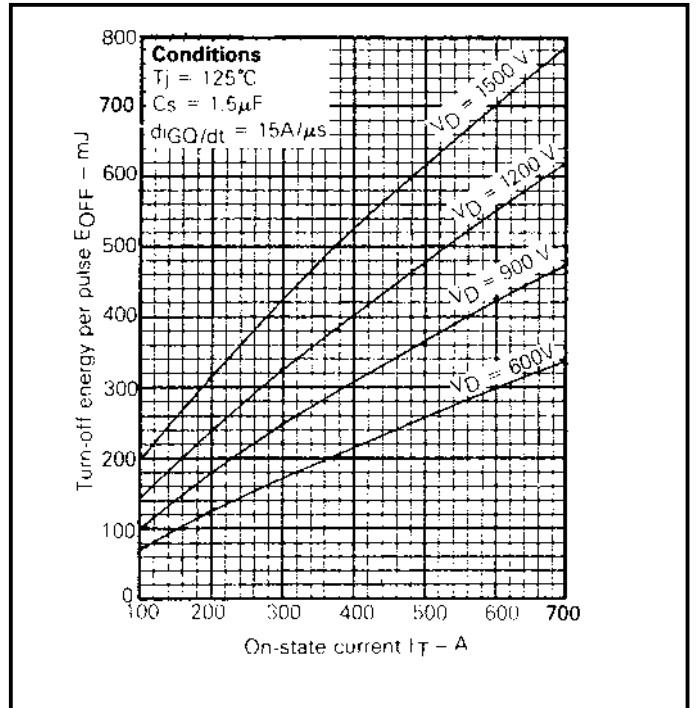
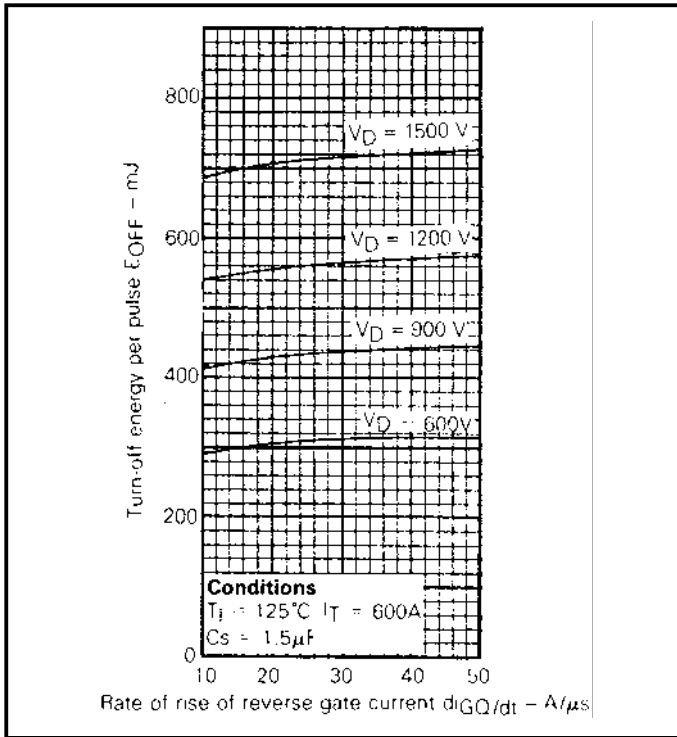
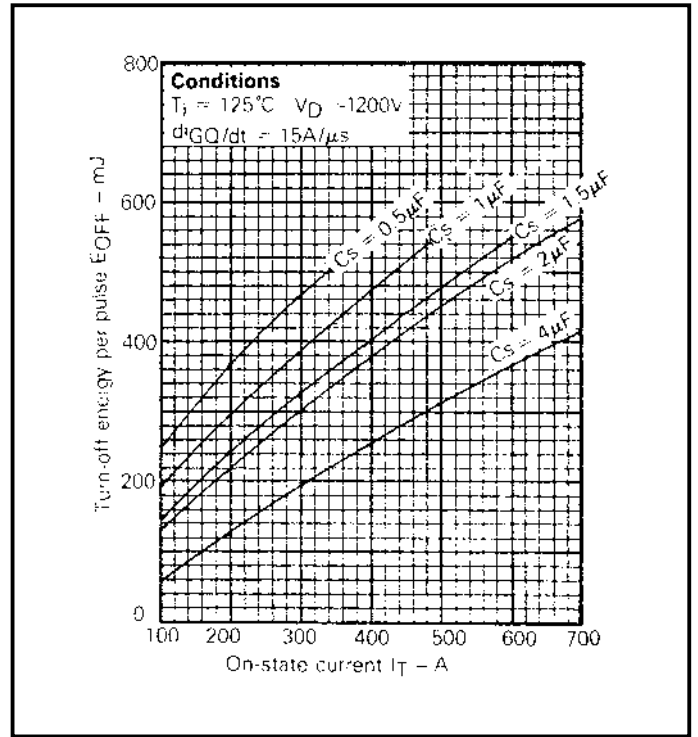

Fig.18 Turn-off energy vs on-state current

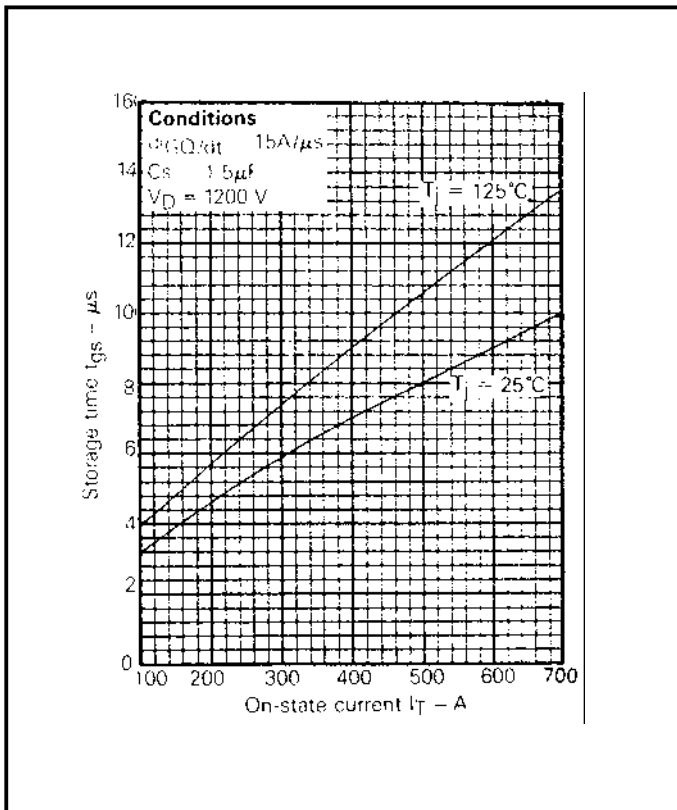



**Fig.19 Turn-off energy vs rate of rise of reverse gate current**



**Fig.20 Turn-off energy vs on-state current with  $C_s$  as parameter**



**Fig.21 Storage time vs on-state current**

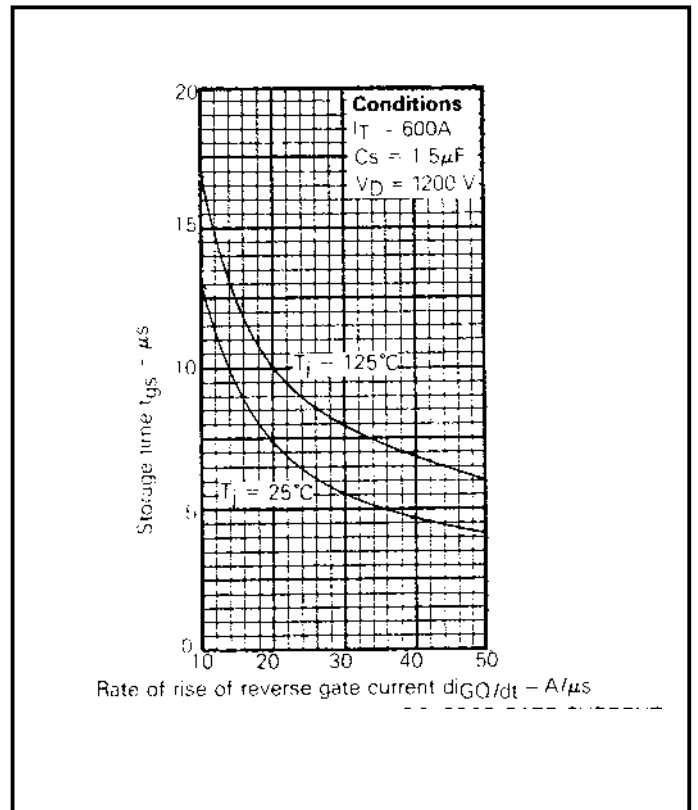

**Fig.22 Storage time vs rate of rise of reverse gate current**

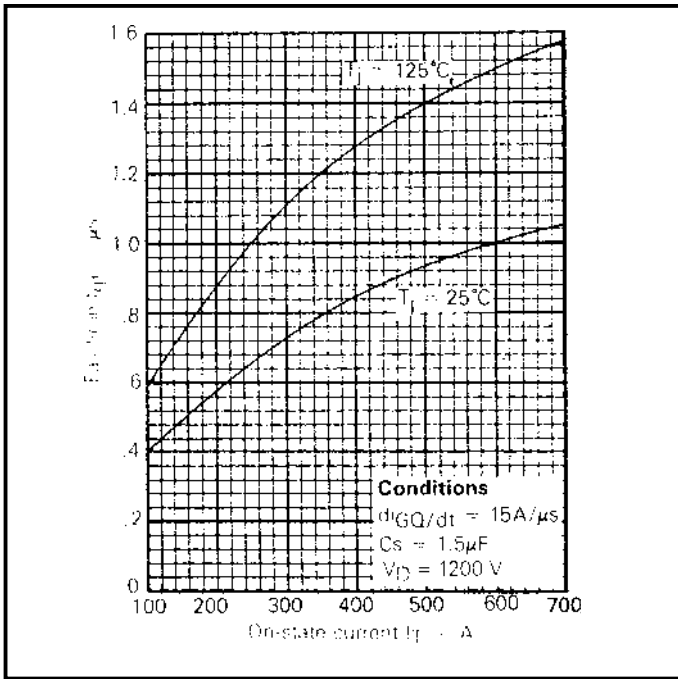

Fig.23 Fall time vs on-state current

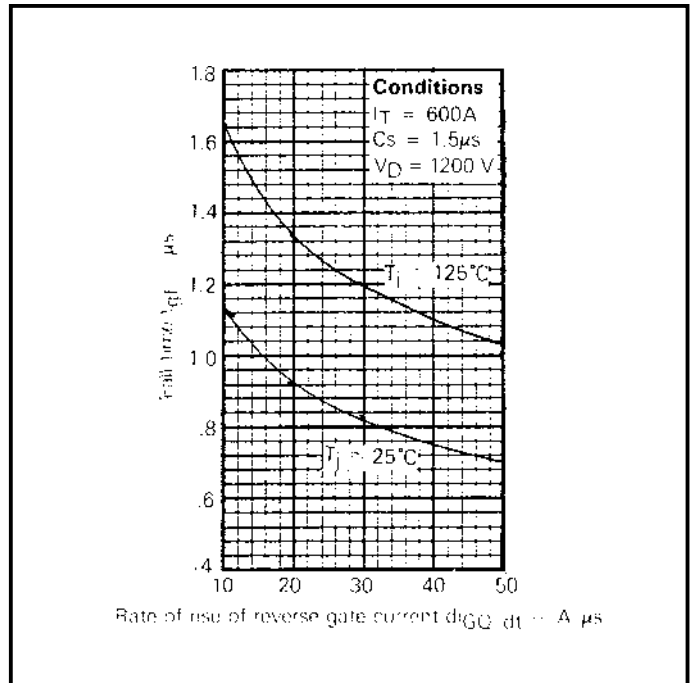

Fig.24 Fall time vs rate of rise of reverse gate current

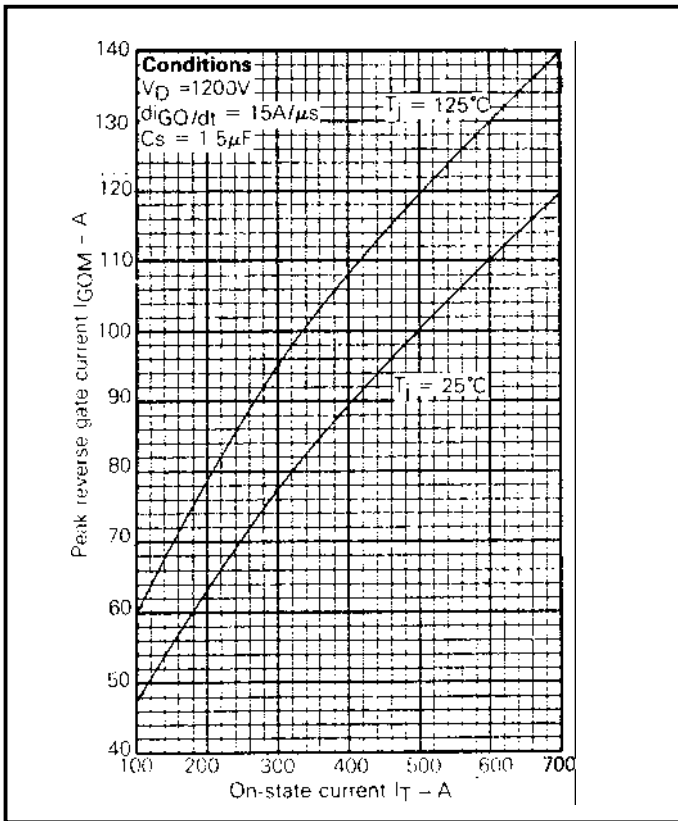

Fig.25 Peak reverse gate current vs on-state current

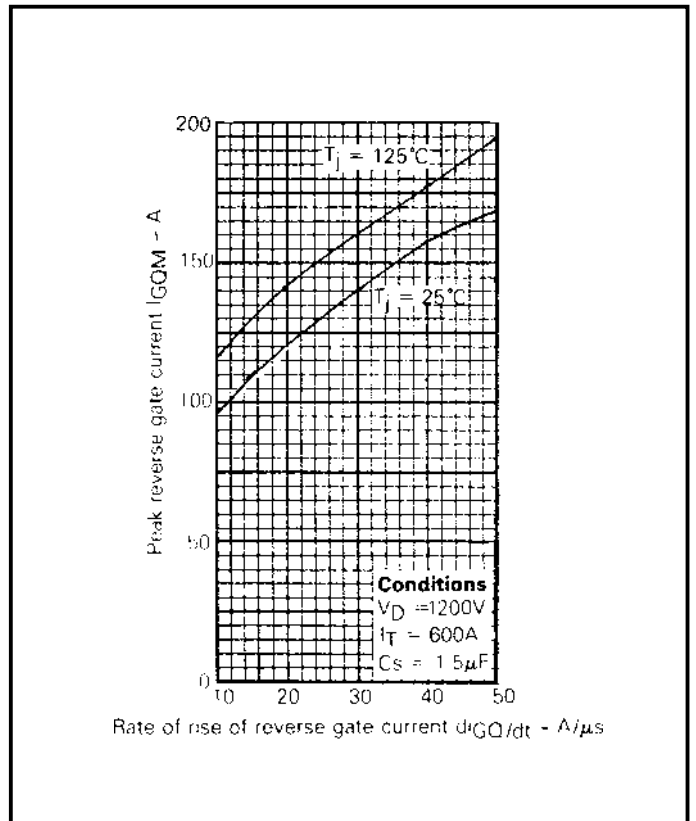
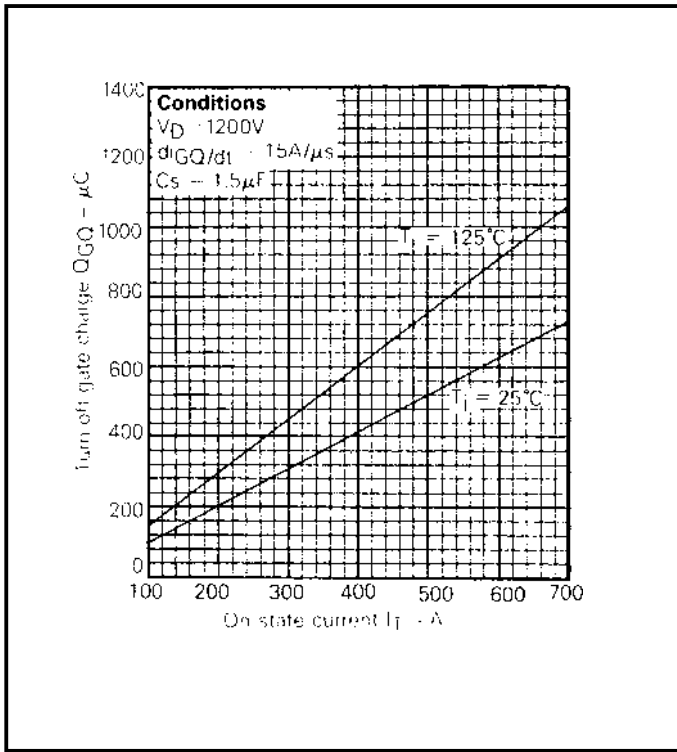
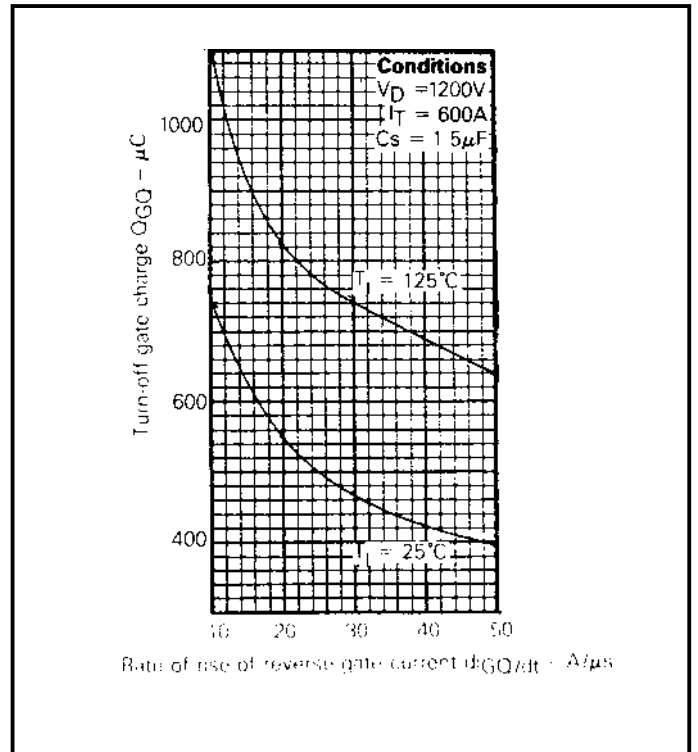

Fig.26 Peak reverse gate current vs rate of rise of reverse gate current



**Fig.27 Turn-off gate charge vs on-state current**



**Fig.28 Turn-off gate charge vs rate of rise of reverse gate current**

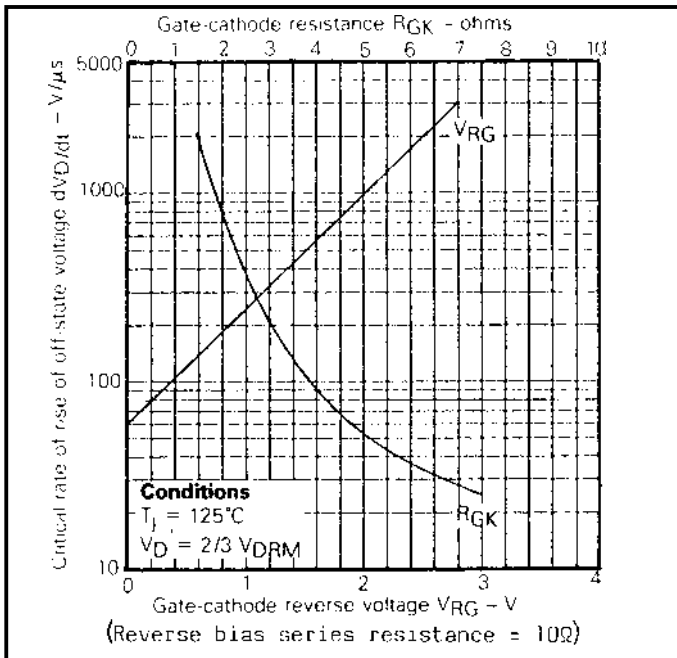

**Fig.29 Dependence of critical  $dv_D/dt$  on gate-cathode resistance and gate-cathode reverse voltage**

Snubber Capacitor $C_s$ ( $\mu F$ )	Snubber Resistor $R_s$ ( $\Omega$ )	Minimum Reset Time ( $\mu s$ )
2	7	35
	5	30
15	7	26
	5	22
1	7	17
	5	15

**Table of snubber discharge time variation with snubber capacitor value.**

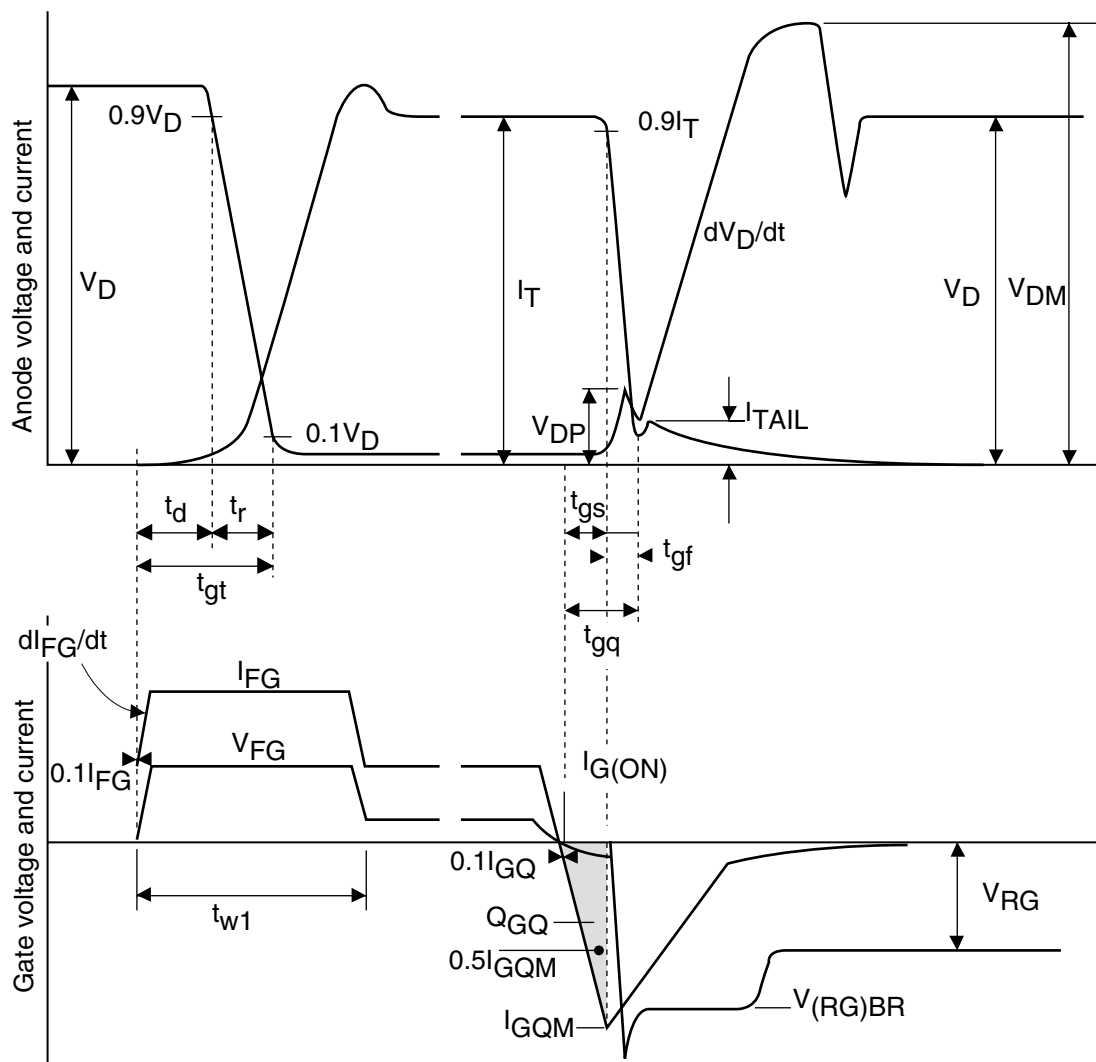

Recommended gate conditions:

$I_{TCM} = 600A$   
 $I_{FG} = 20A$   
 $I_{G(ON)} = 2A \text{ d.c.}$   
 $t_{w1(\text{min})} = 4.5\mu s$   
 $I_{GQM} = 130A$   
 $di_{GQ}/dt = 15A/\mu s$   
 $Q_{GQ} = 900\mu C$   
 $V_{RG(\text{min})} = 2V$   
 $V_{RG(\text{max})} = 16V$

These are recommended Dynex Semiconductor conditions. Other conditions are permitted according to users gate drive specifications.

Fig.30 General switching waveforms

**PACKAGE DETAILS**

For further package information, please contact Customer Services. All dimensions in mm, unless stated otherwise. DO NOT SCALE.

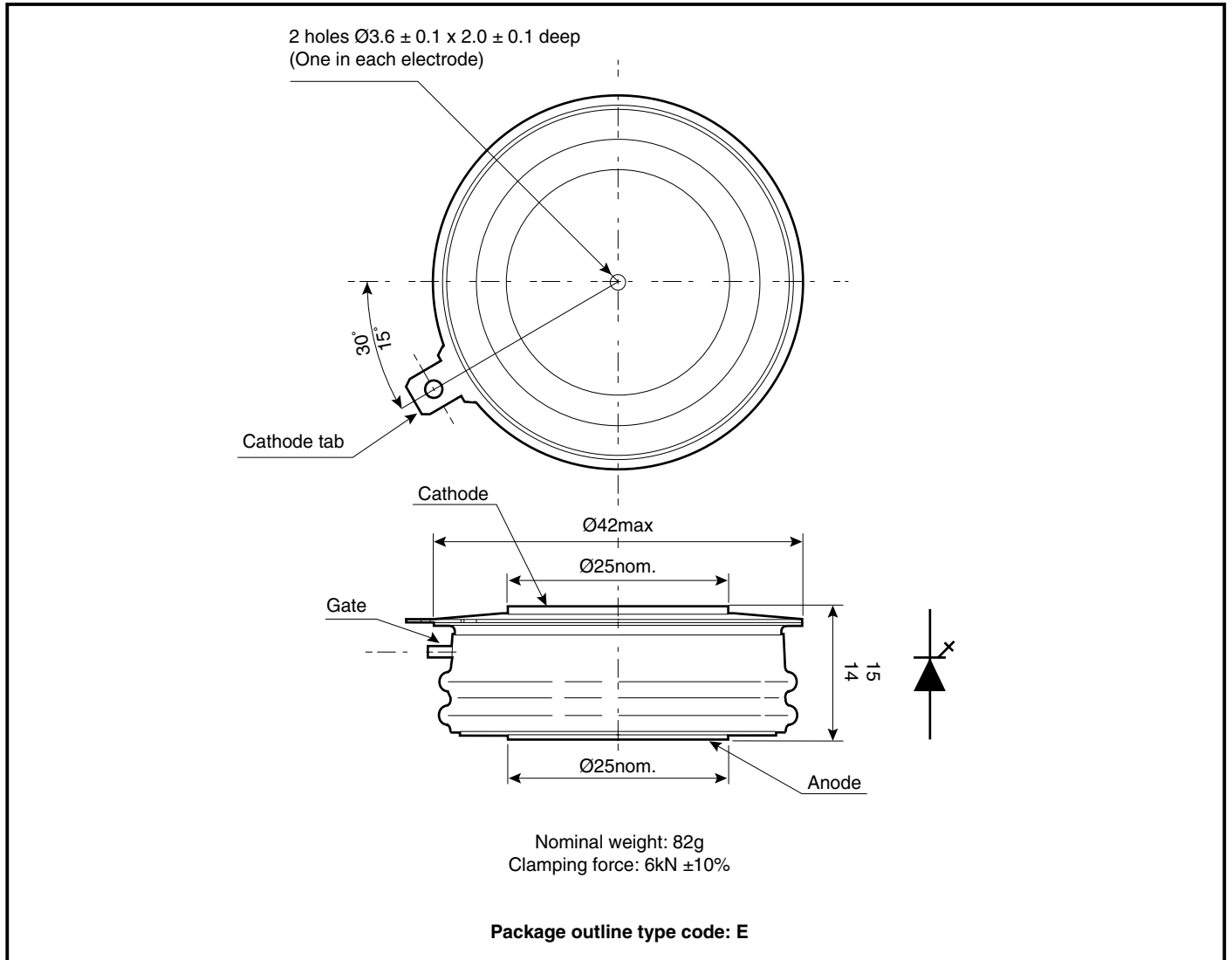

## POWER ASSEMBLY CAPABILITY

The Power Assembly group was set up to provide a support service for those customers requiring more than the basic semiconductor, and has developed a flexible range of heatsink and clamping systems in line with advances in device voltages and current capability of our semiconductors.

We offer an extensive range of air and liquid cooled assemblies covering the full range of circuit designs in general use today. The Assembly group offers high quality engineering support dedicated to designing new units to satisfy the growing needs of our customers.

Using the latest CAD methods our team of design and applications engineers aim to provide the Power Assembly Complete Solution (PACs).

## HEATSINKS

The Power Assembly group has its own proprietary range of extruded aluminium heatsinks which have been designed to optimise the performance of Dynex semiconductors. Data with respect to air natural, forced air and liquid cooling (with flow rates) is available on request.

For further information on device clamps, heatsinks and assemblies, please contact your nearest sales representative or Customer Services.

Stresses above those listed in this data sheet may cause permanent damage to the device. In extreme conditions, as with all semiconductors, this may include potentially hazardous rupture of the package. Appropriate safety precautions should always be followed.



<http://www.dynexsemi.com>

**e-mail: [power\\_solutions@dynexsemi.com](mailto:power_solutions@dynexsemi.com)**

### HEADQUARTERS OPERATIONS

#### **DYNEX SEMICONDUCTOR LTD**

Doddington Road, Lincoln.  
Lincolnshire. LN6 3LF. United Kingdom.  
Tel: +44-(0)1522-500500  
Fax: +44-(0)1522-500550

### CUSTOMER SERVICE

Tel: +44 (0)1522 502753 / 502901. Fax: +44 (0)1522 500020

### SALES OFFICES

**Benelux, Italy & Switzerland:** Tel: +33 (0)1 60 69 32 36. Fax: +33 (0)1 60 69 31 97.

**France:** Tel: +33 (0)2 47 55 75 53. Fax: +33 (0)2 47 55 75 59. Tel: +33 (0)1 60 69 32 36. Fax: +33 (0)1 60 69 31 97

**Germany, Northern Europe, Spain & Rest Of World:** Tel: +44 (0)1522 502753 / 502901.

Fax: +44 (0)1522 500020

**North America:** Tel: (440) 259-2060. Fax: (440) 259-2059. Tel: (949) 733-3005. Fax: (949) 733-2986.

These offices are supported by Representatives and Distributors in many countries world-wide.

© Dynex Semiconductor 2003 TECHNICAL DOCUMENTATION – NOT FOR RESALE. PRODUCED IN UNITED KINGDOM

This publication is issued to provide information only which (unless agreed by the Company in writing) may not be used, applied or reproduced for any purpose nor form part of any order or contract nor to be regarded as a representation relating to the products or services concerned. No warranty or guarantee express or implied is made regarding the capability, performance or suitability of any product or service. The Company reserves the right to alter without prior notice the specification, design or price of any product or service. Information concerning possible methods of use is provided as a guide only and does not constitute any guarantee that such methods of use will be satisfactory in a specific piece of equipment. It is the user's responsibility to fully determine the performance and suitability of any equipment using such information and to ensure that any publication or data used is up to date and has not been superseded. These products are not suitable for use in any medical products whose failure to perform may result in significant injury or death to the user. All products and materials are sold and services provided subject to the Company's conditions of sale, which are available on request.

All brand names and product names used in this publication are trademarks, registered trademarks or trade names of their respective owners.