

FEATURES

- Double Side Cooling
- High Reliability In Service
- High Voltage Capability
- Fault Protection Without Fuses
- High Surge Current Capability
- Turn-off Capability Allows Reduction In Equipment Size And Weight. Low Noise Emission Reduces Acoustic Cladding Necessary For Environmental Requirements

APPLICATIONS

- Variable speed A.C. motor drive inverters (VSD-AC)
- Uninterruptable Power Supplies
- High Voltage Converters
- Choppers
- Welding
- Induction Heating
- DC/DC Converters

KEY PARAMETERS

I_{TCM}	3000A
V_{DRM}	4500V
$I_{T(AV)}$	1180A
dV_D/dt	1000V/ μ s
di_T/dt	300A/ μ s

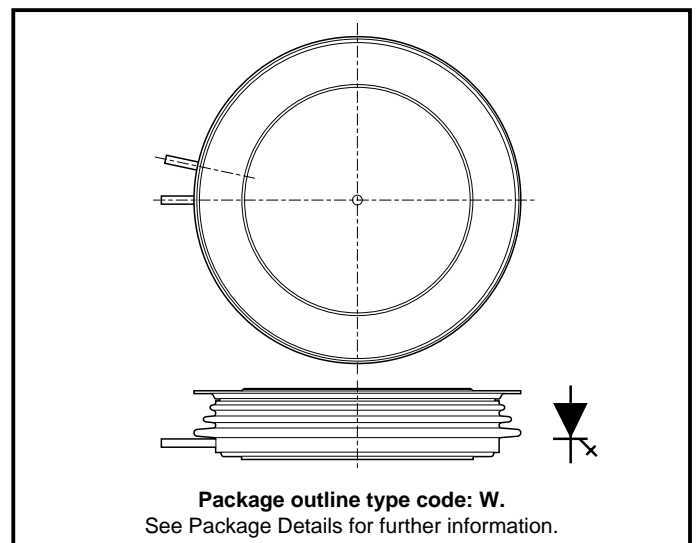

Figure 1. Package outline

VOLTAGE RATINGS

Type Number	Repetitive Peak Off-state Voltage V_{DRM} V	Repetitive Peak Reverse Voltage V_{RRM} V	Conditions
DG858BW45	4500	16	$T_{vj} = 125^\circ\text{C}$, $I_{DM} = 100\text{mA}$, $I_{RRM} = 50\text{mA}$

CURRENT RATINGS

Symbol	Parameter	Conditions	Max.	Units
I_{TCM}	Repetitive peak controllable on-state current	$V_D = 66\% V_{DRM}$, $T_j = 125^\circ\text{C}$, $di_{GD}/dt = 40\text{A}/\mu\text{s}$, $C_s = 3\mu\text{F}$	3000	A
$I_{T(AV)}$	Mean on-state current	$T_{HS} = 80^\circ\text{C}$. Double side cooled, half sine 50Hz	1180	A
$I_{T(RMS)}$	RMS on-state current	$T_{HS} = 80^\circ\text{C}$. Double side cooled, half sine 50Hz	1850	A

DG858BW45

SURGE RATINGS

Symbol	Parameter	Conditions	Max.	Units
I_{TSM}	Surge (non-repetitive) on-state current	10ms half sine. $T_j = 125^\circ\text{C}$	20.0	kA
I^2t	I^2t for fusing	10ms half sine. $T_j = 125^\circ\text{C}$	2.0×10^6	A^2s
di_T/dt	Critical rate of rise of on-state current	$V_D = 3000\text{V}$, $I_T = 3000\text{A}$, $T_j = 125^\circ\text{C}$, $I_{FG} > 40\text{A}$, Rise time $> 1.0\mu\text{s}$	300	$\text{A}/\mu\text{s}$
dV_D/dt	Rate of rise of off-state voltage	To 66% V_{DRM} ; $R_{GK} \leq 1.5\Omega$, $T_j = 125^\circ\text{C}$	130	$\text{V}/\mu\text{s}$
		To 66% V_{DRM} ; $V_{RG} = -2\text{V}$, $T_j = 125^\circ\text{C}$	1000	$\text{V}/\mu\text{s}$
L_S	Peak stray inductance in snubber circuit	$I_T = 3000\text{A}$, $V_D = V_{DRM}$, $T_j = 125^\circ\text{C}$, $di_{GQ} = 40\text{A}/\mu\text{s}$, $C_s = 3.0\mu\text{F}$	200	nH

GATE RATINGS

Symbol	Parameter	Conditions	Min.	Max.	Units
V_{RGM}	Peak reverse gate voltage	This value maybe exceeded during turn-off	-	16	V
I_{FGM}	Peak forward gate current		20	100	A
$P_{FG(AV)}$	Average forward gate power		-	20	W
P_{RGM}	Peak reverse gate power		-	24	kW
di_{GQ}/dt	Rate of rise of reverse gate current		20	60	$\text{A}/\mu\text{s}$
$t_{ON(min)}$	Minimum permissible on time		50	-	μs
$t_{OFF(min)}$	Minimum permissible off time		100	-	μs

THERMAL AND MECHANICAL DATA

Symbol	Parameter	Conditions	Min.	Max.	Units
$R_{th(j-hs)}$	DC thermal resistance - junction to heatsink surface	Double side cooled	-	0.011	$^\circ\text{C}/\text{W}$
		Anode side cooled	-	0.017	$^\circ\text{C}/\text{W}$
		Cathode side cooled	-	0.03	$^\circ\text{C}/\text{W}$
$R_{th(c-hs)}$	Contact thermal resistance	Clamping force 40.0kN With mounting compound	per contact	-	0.0021 $^\circ\text{C}/\text{W}$
T_{vj}	Virtual junction temperature		-40	125	$^\circ\text{C}$
T_{OP}/T_{stg}	Operating junction/storage temperature range		-40	125	$^\circ\text{C}$
-	Clamping force		36.0	44.0	kN

CHARACTERISTICS

T _j = 125°C unless stated otherwise					
Symbol	Parameter	Conditions	Min.	Max.	Units
V _{TM}	On-state voltage	At 4000A peak, I _{G(ON)} = 10A d.c.	-	4.0	V
I _{DM}	Peak off-state current	V _{DRM} = 4500V, V _{RG} = 0V	-	100	mA
I _{RRM}	Peak reverse current	At V _{RRM}	-	50	mA
V _{GT}	Gate trigger voltage	V _D = 24V, I _T = 100A, T _j = 25°C	-	1.2	V
I _{GT}	Gate trigger current	V _D = 24V, I _T = 100A, T _j = 25°C	-	4.0	A
I _{RGM}	Reverse gate cathode current	V _{RGM} = 16V, No gate/cathode resistor	-	50	mA
E _{ON}	Turn-on energy	V _D = 2000V	-	2700	mJ
t _d	Delay time	I _T = 3000A, di _T /dt = 300A/μs	-	2.0	μs
t _r	Rise time	I _{FG} = 40A, rise time < 1.0μs	-	6.0	μs
E _{OFF}	Turn-off energy		-	13500	mJ
t _{gs}	Storage time		-	25.0	μs
t _{gf}	Fall time	I _T = 3000A, V _{DM} = V _{DRM}	-	2.5	μs
t _{gq}	Gate controlled turn-off time	Snubber Cap Cs = 3.0μF,	-	27.5	μs
Q _{GQ}	Turn-off gate charge	di _{GQ} /dt = 40A/μs	-	12000	μC
Q _{GQT}	Total turn-off gate charge		-	24000	μC
I _{GQM}	Peak reverse gate current		-	950	A

CURVES

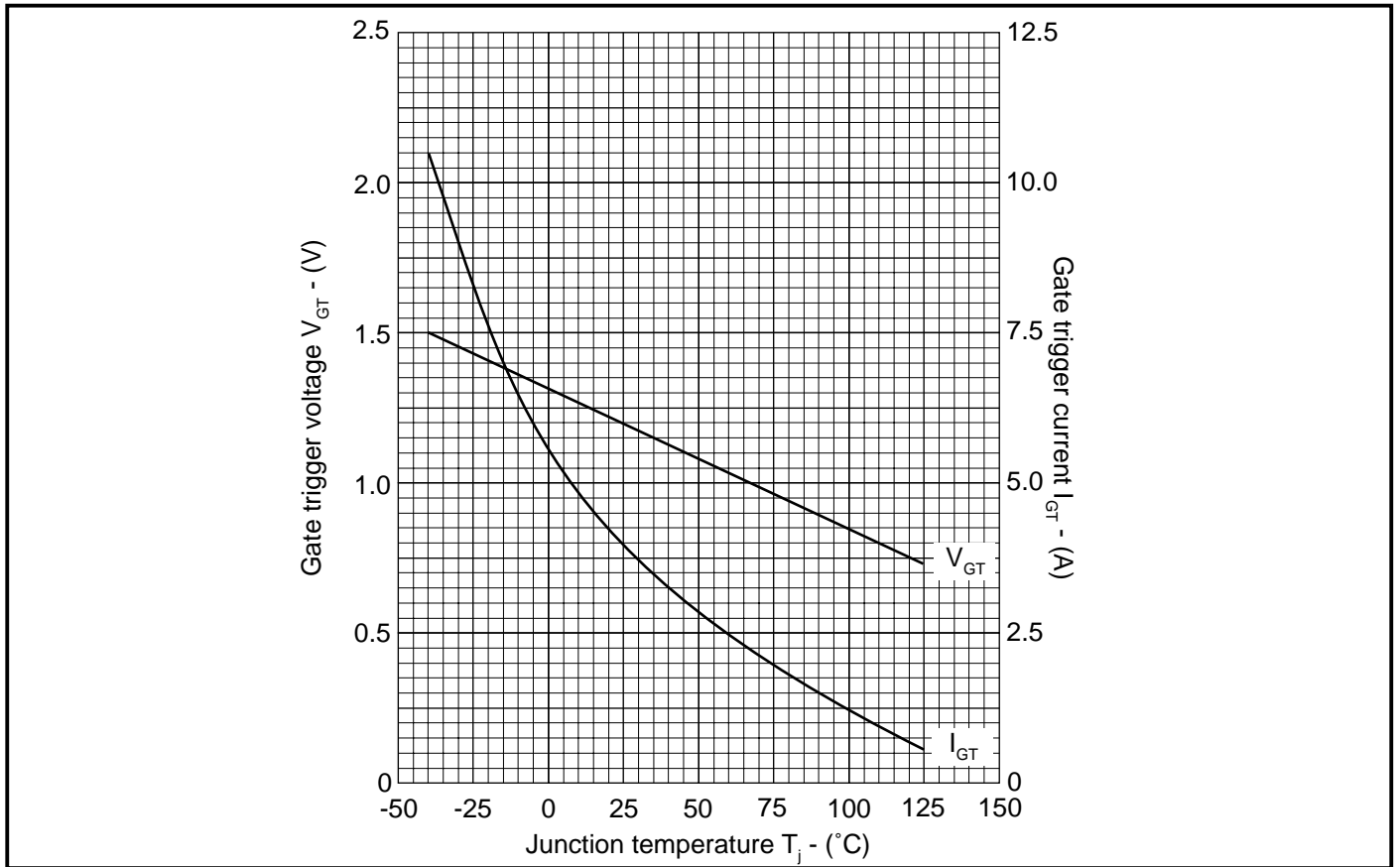

Figure 2. Maximum gate trigger voltage/current vs junction temperature

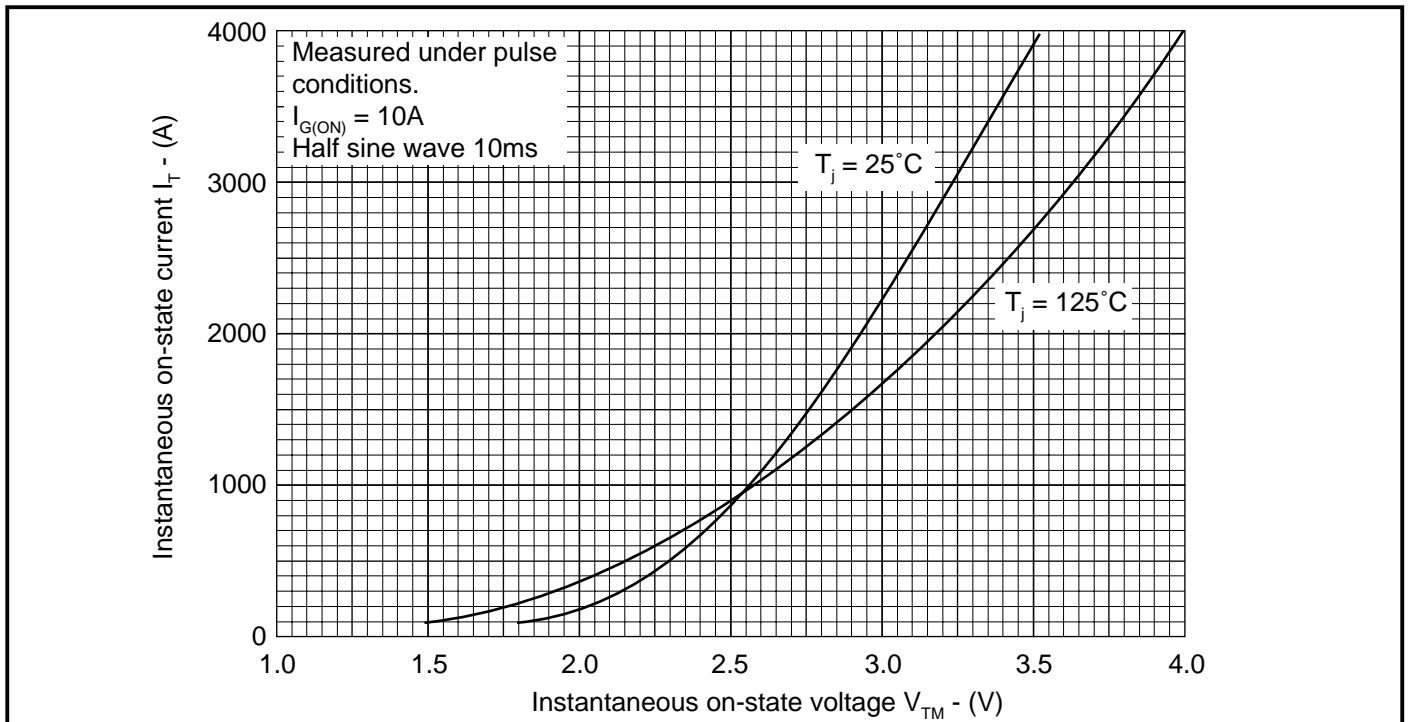

Figure 3. On-state characteristics

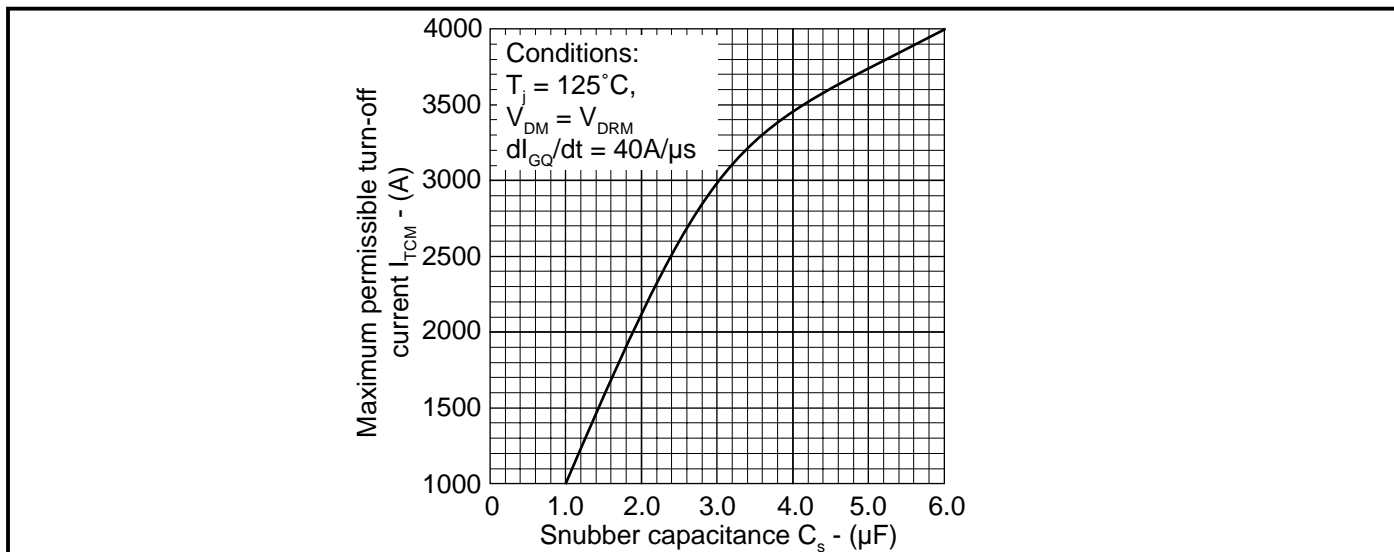

Figure 4. Maximum dependence of I_{TCM} on C_s

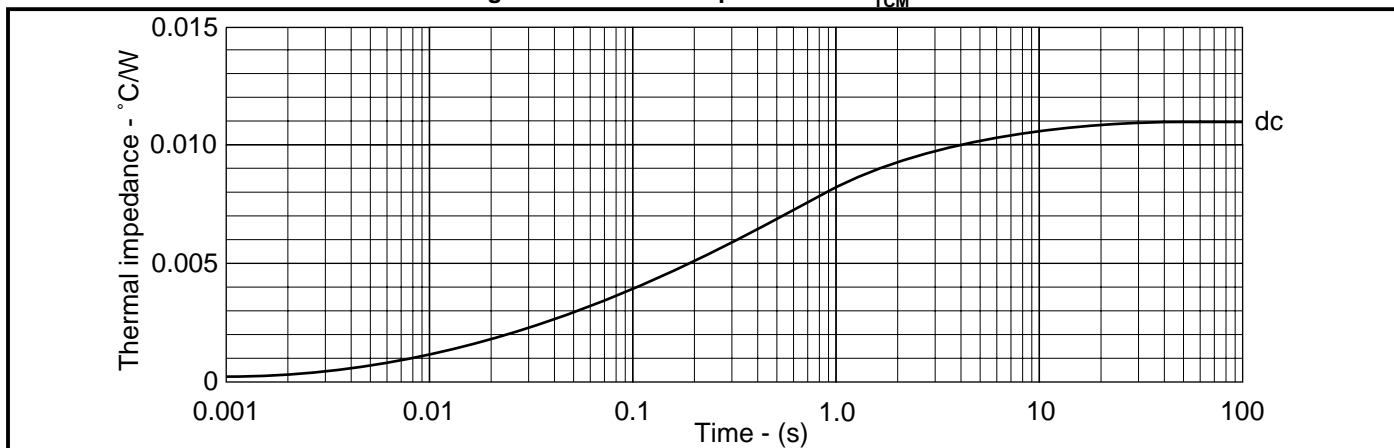

Figure 5. Maximum (limit) transient thermal impedance - double side cooled

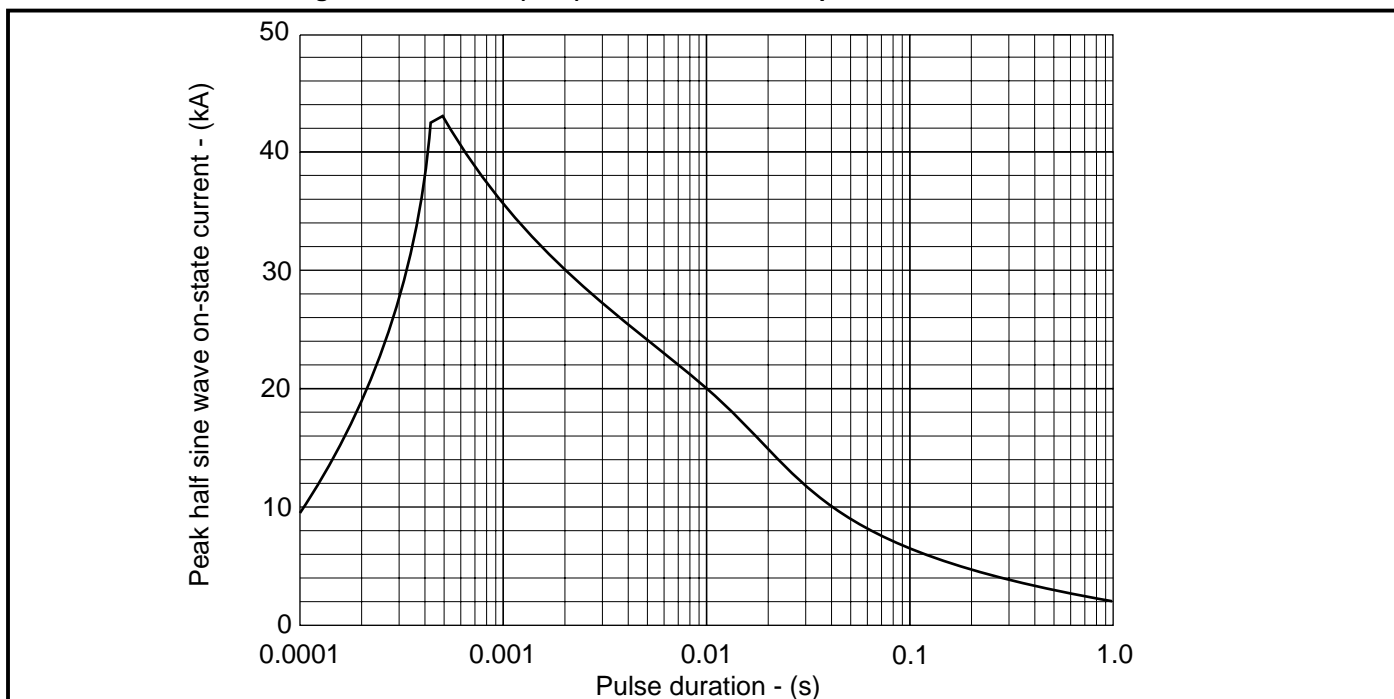

Figure 6. Surge (non-repetitive) on-state current vs time

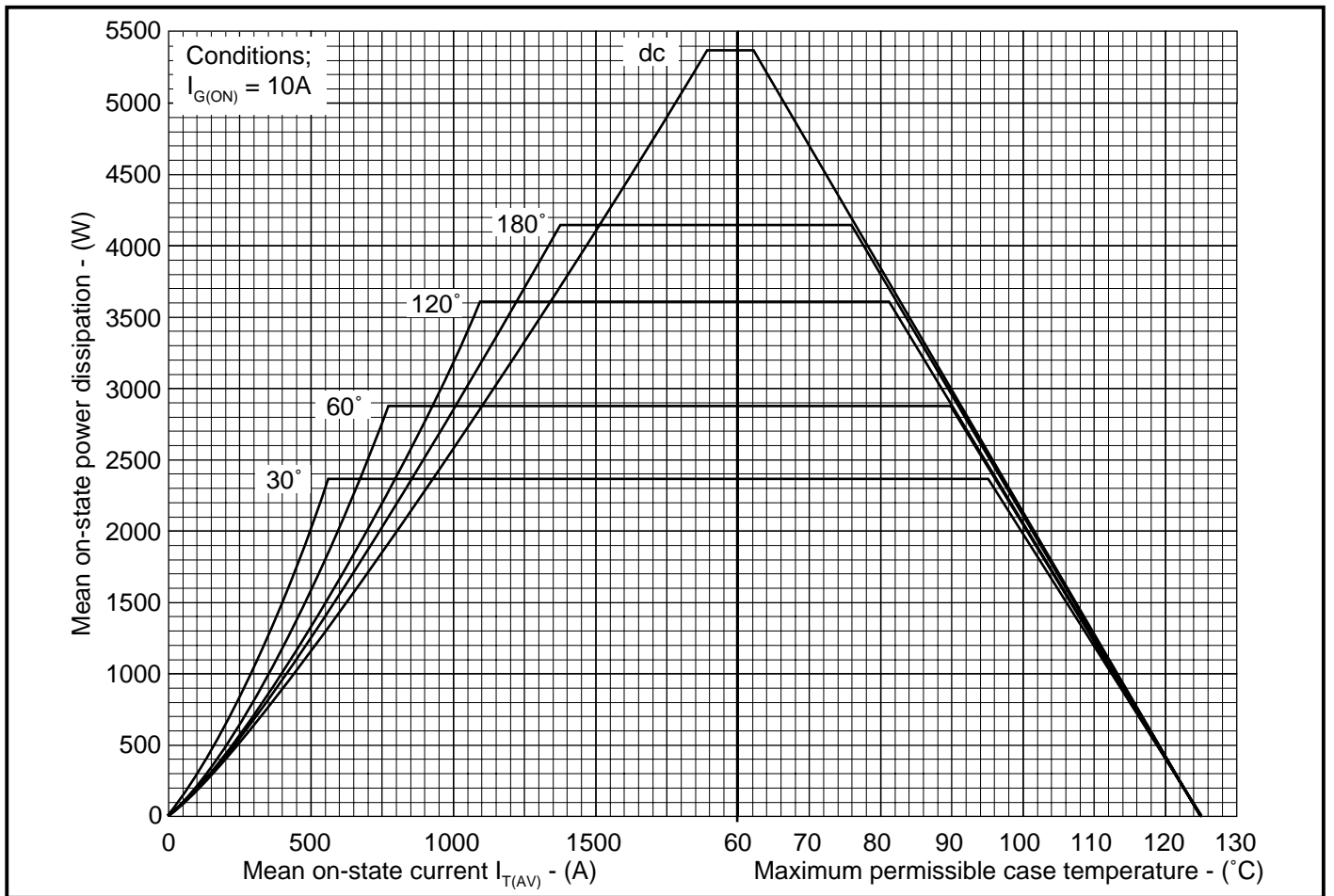

Figure 7. Steady state rectangular wave conduction loss - double side cooled

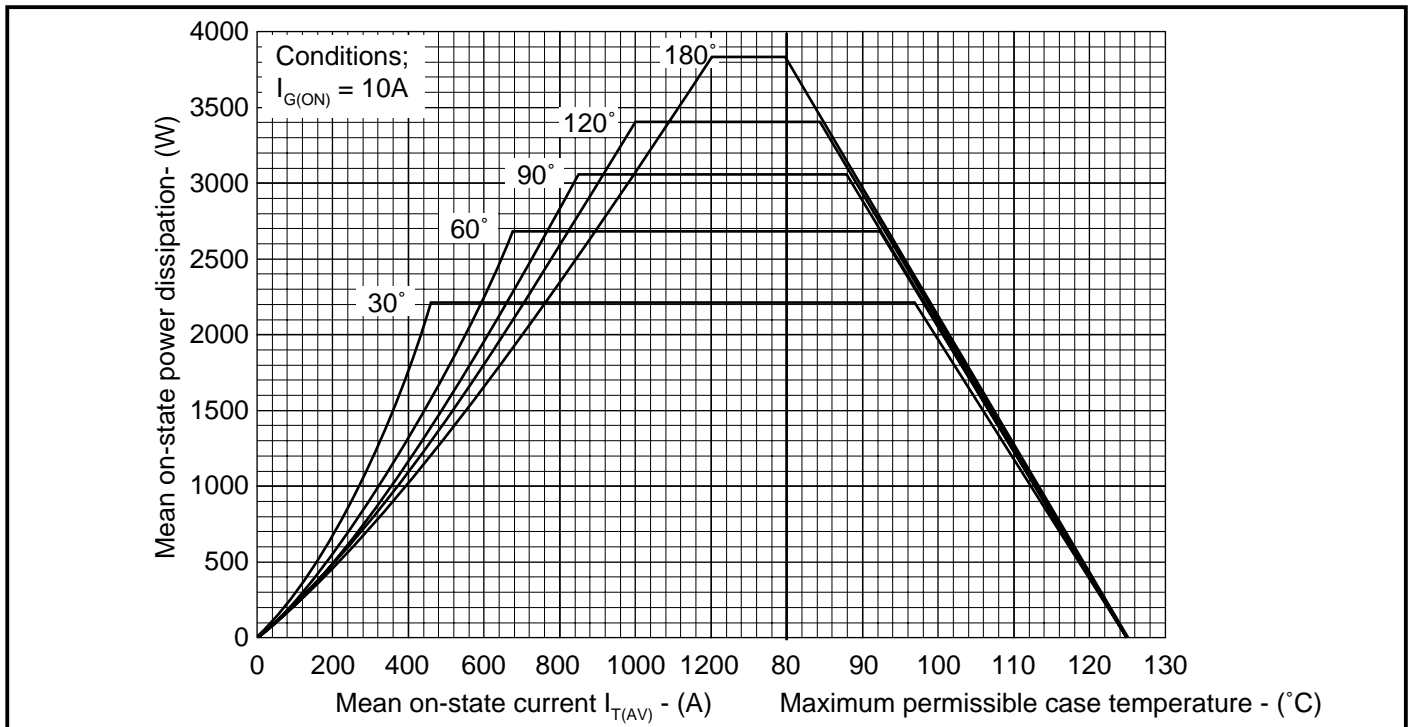

Figure 8. Steady state sinusoidal wave conduction loss - double side cooled

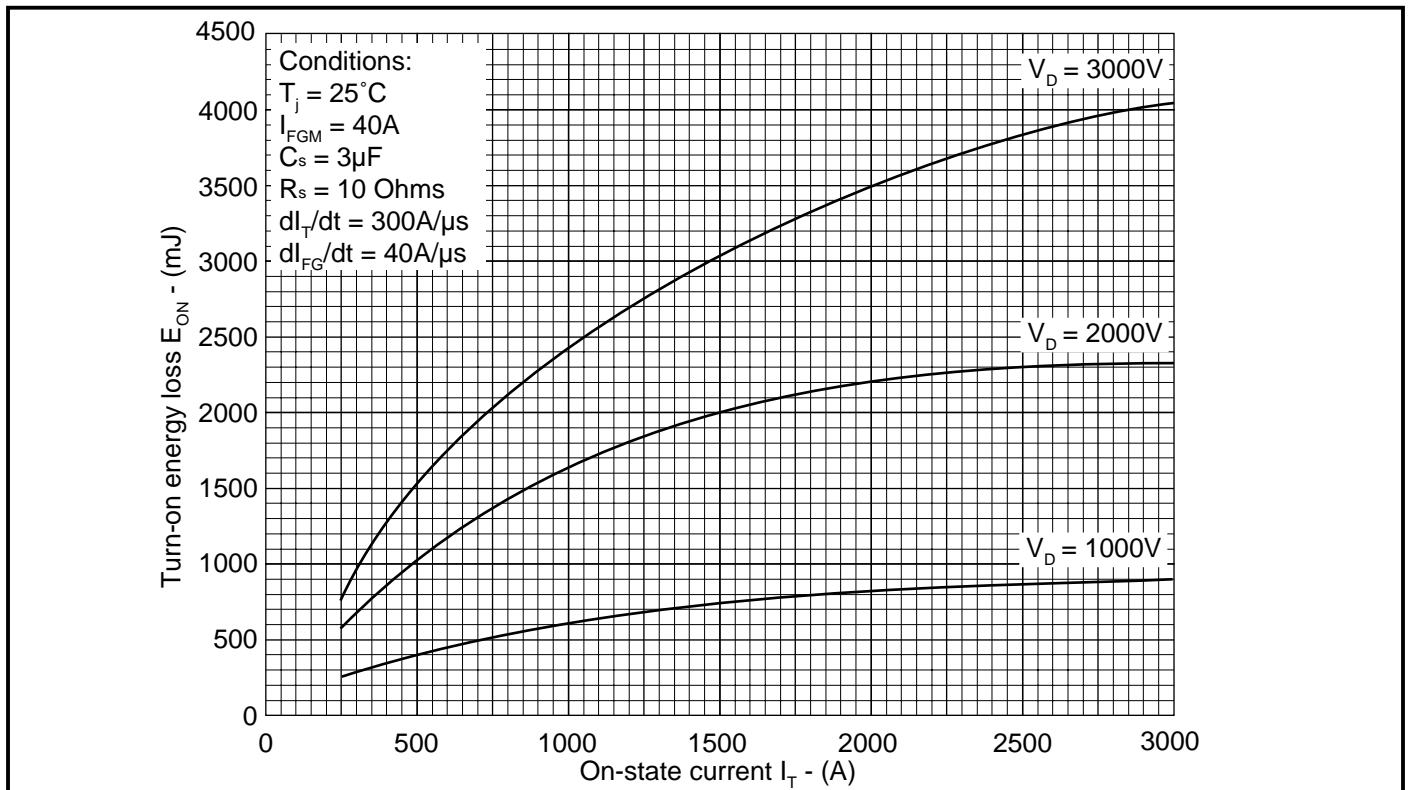

Figure 9. Turn-on energy vs on-state current

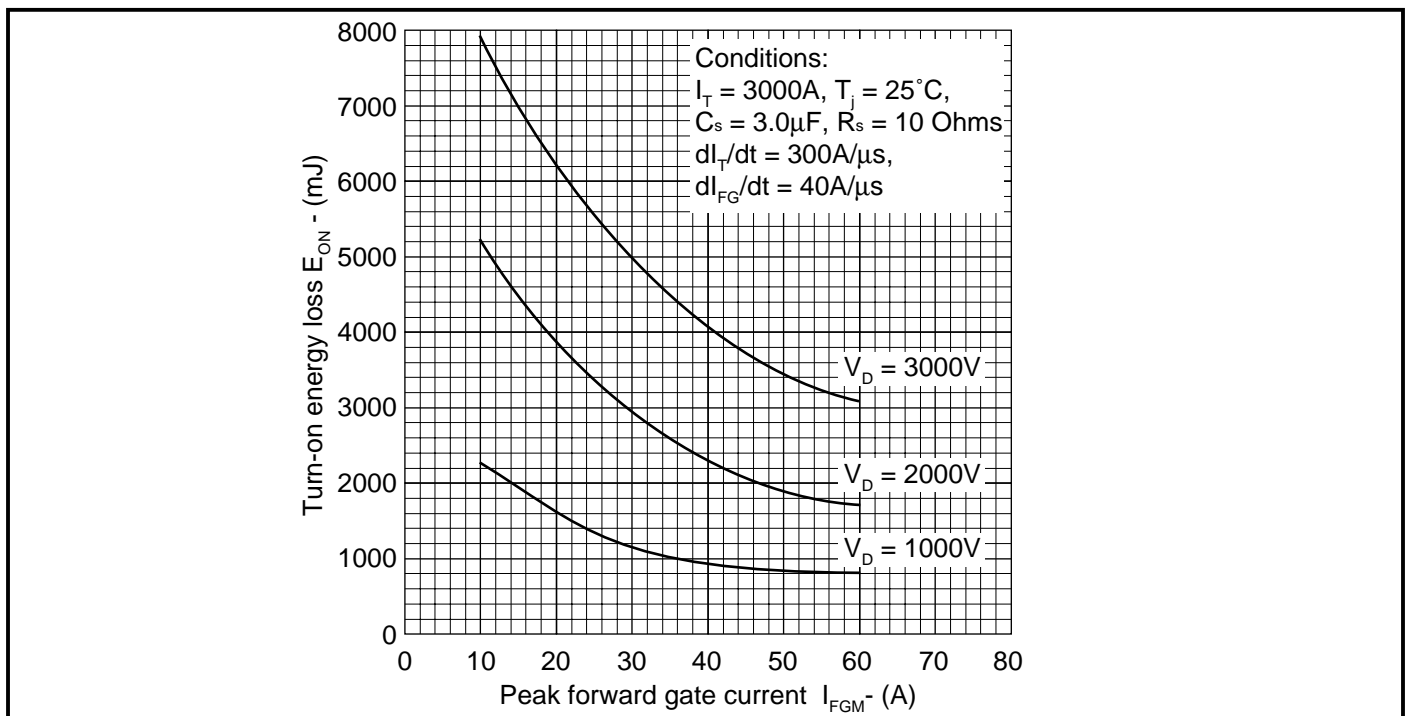

Figure 10. Turn-on energy vs peak forward gate current

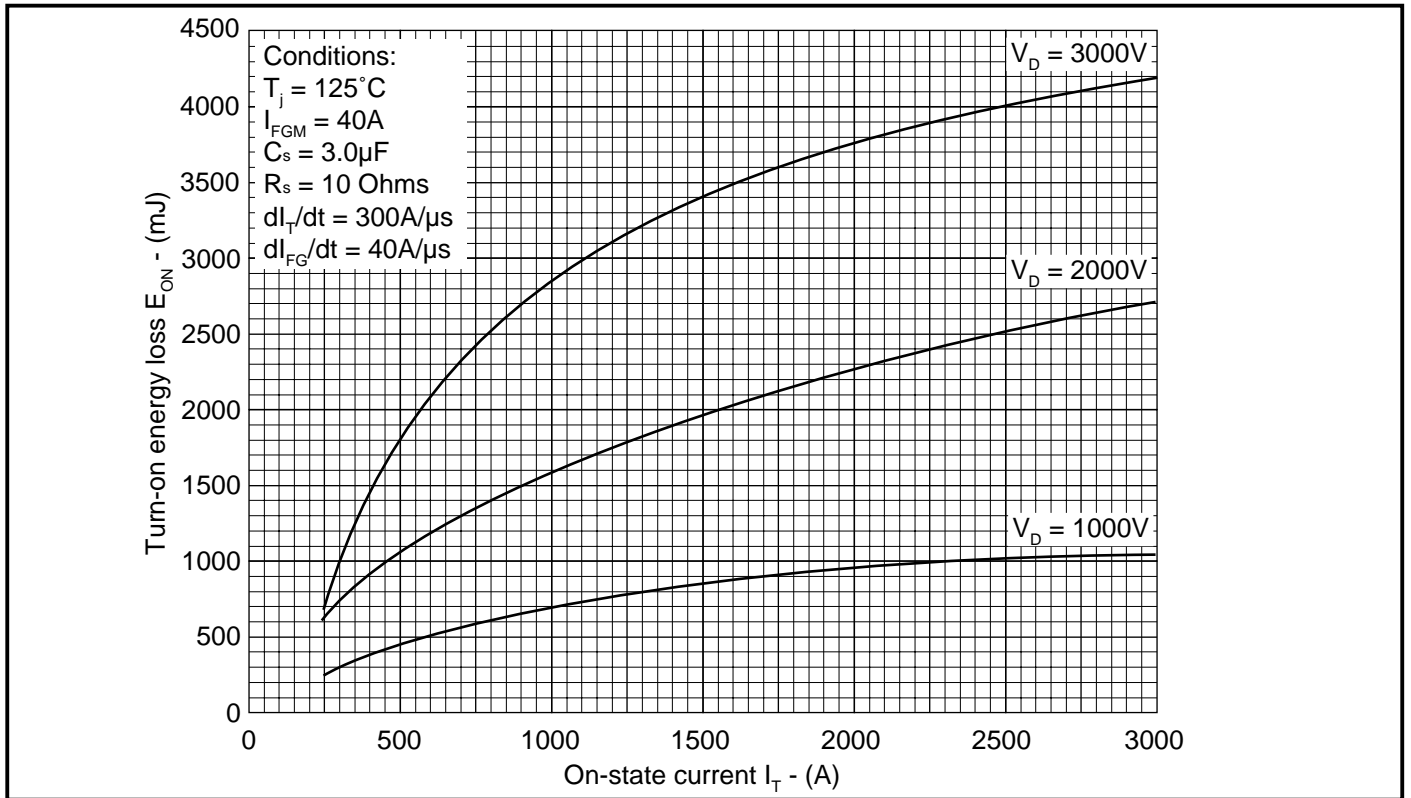

Figure 11. Turn-on energy vs on-state current

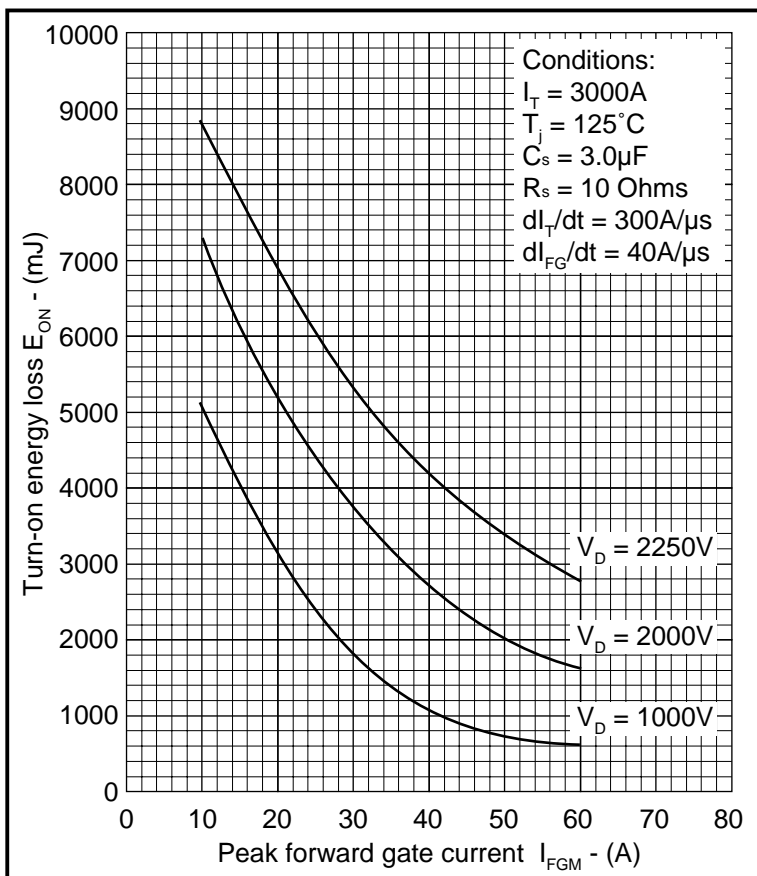

Figure 12. Turn-on energy vs peak forward gate current

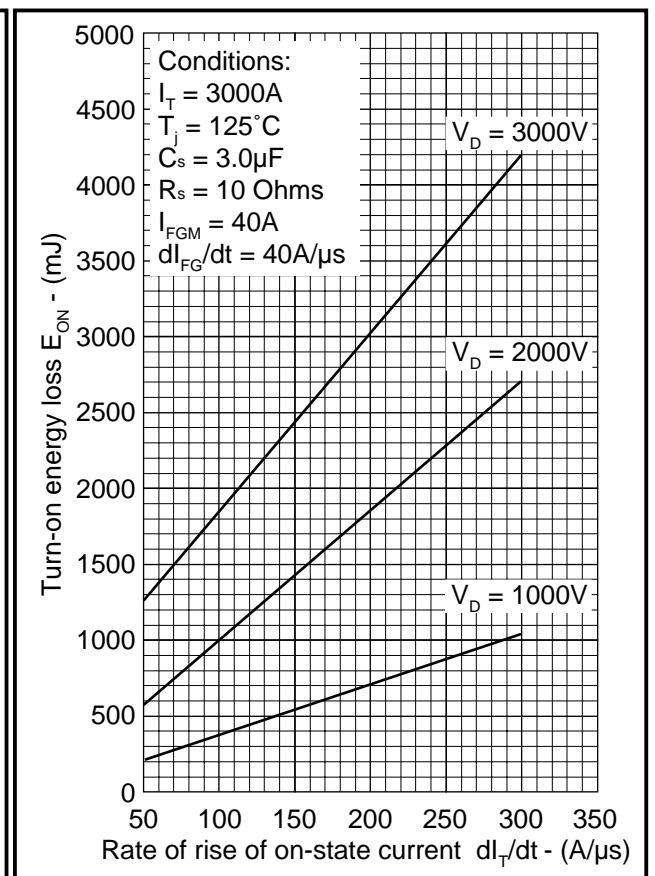

Figure 13. Turn-on energy vs rate of rise of on-state current

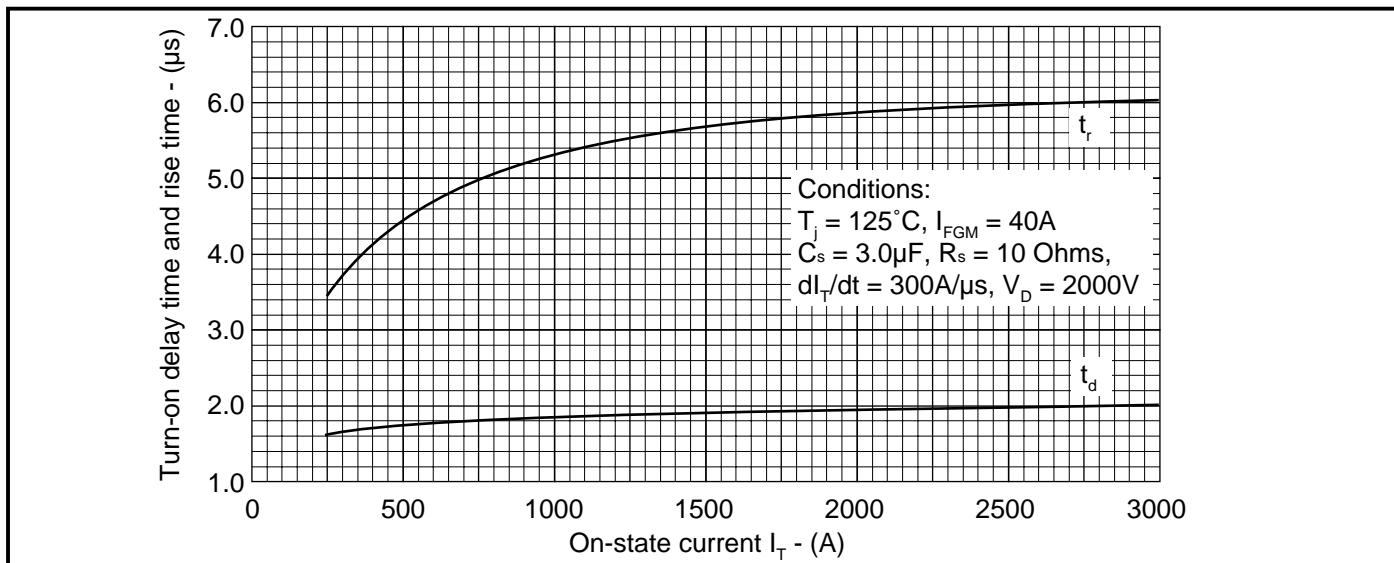

Figure 14. Delay and rise time vs on-state current

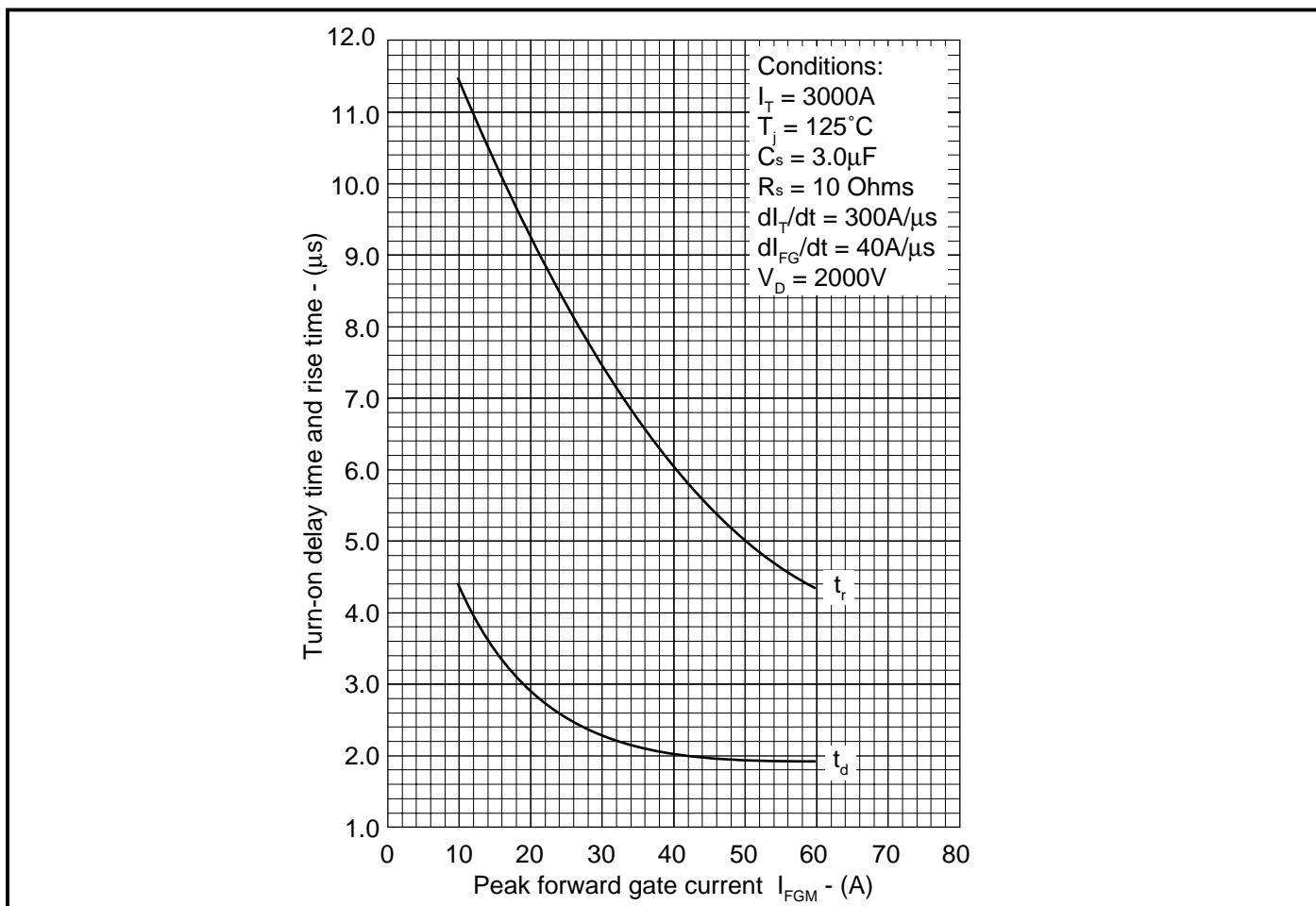

Figure 15. Delay and rise time vs peak forward gate current

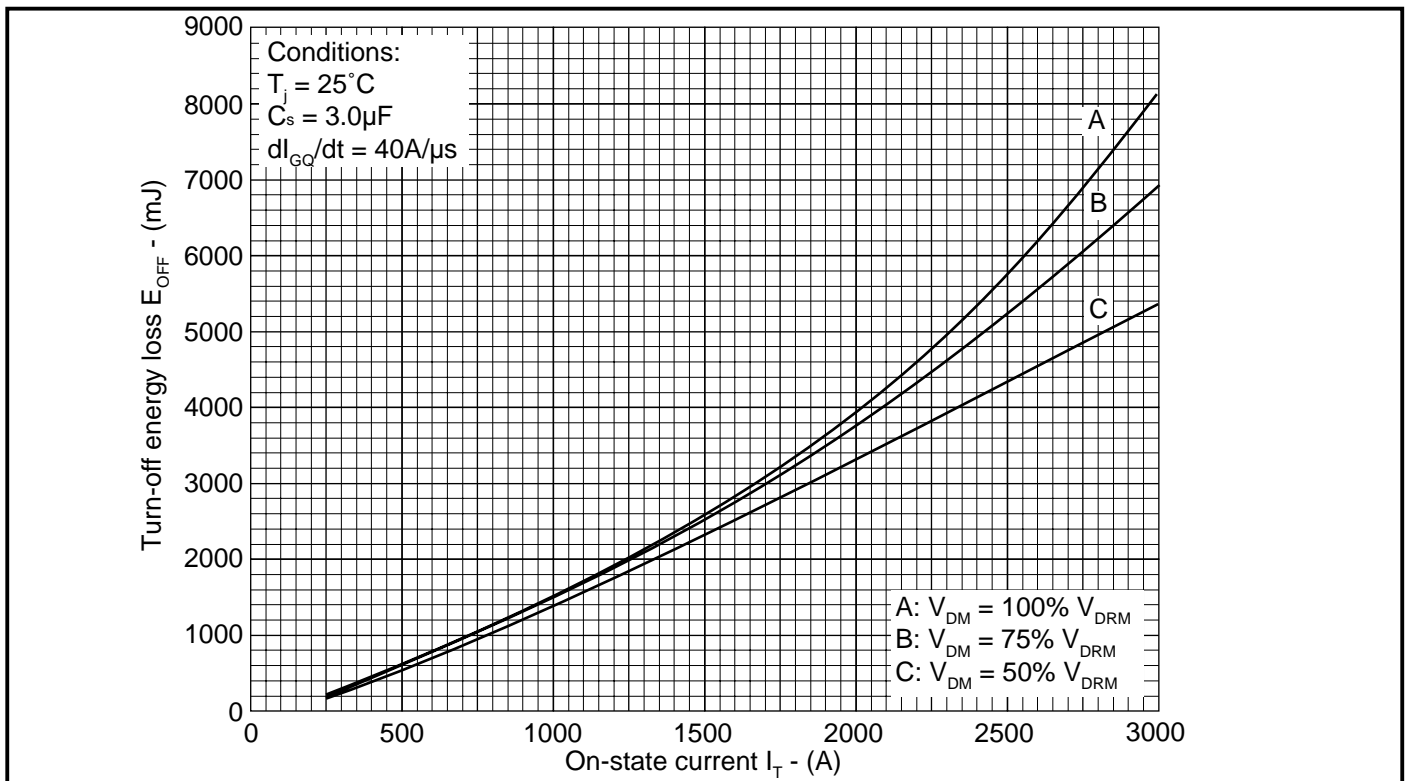

Figure 16. Turn-off energy loss vs on-state current

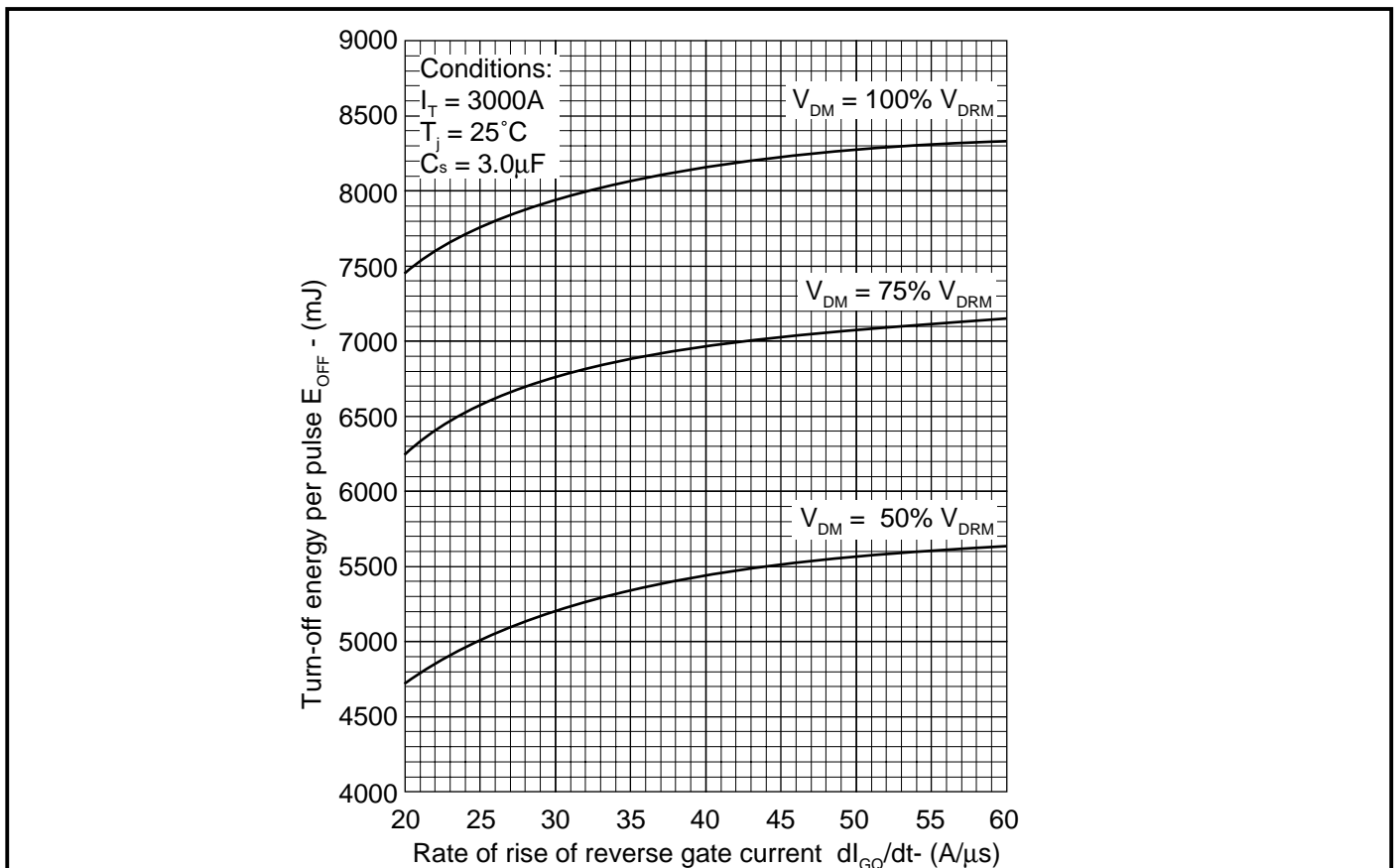

Figure 17. Turn-off energy vs rate of rise of reverse gate current

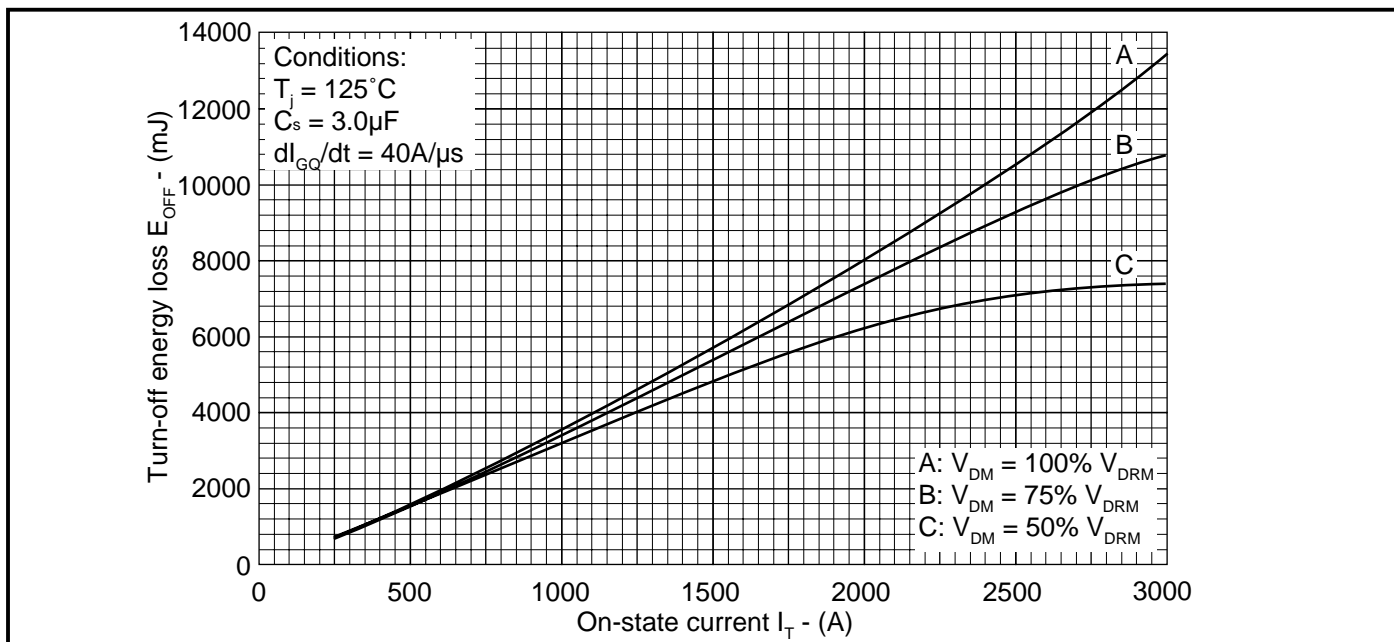

Figure 18. Turn-off energy vs on-state current

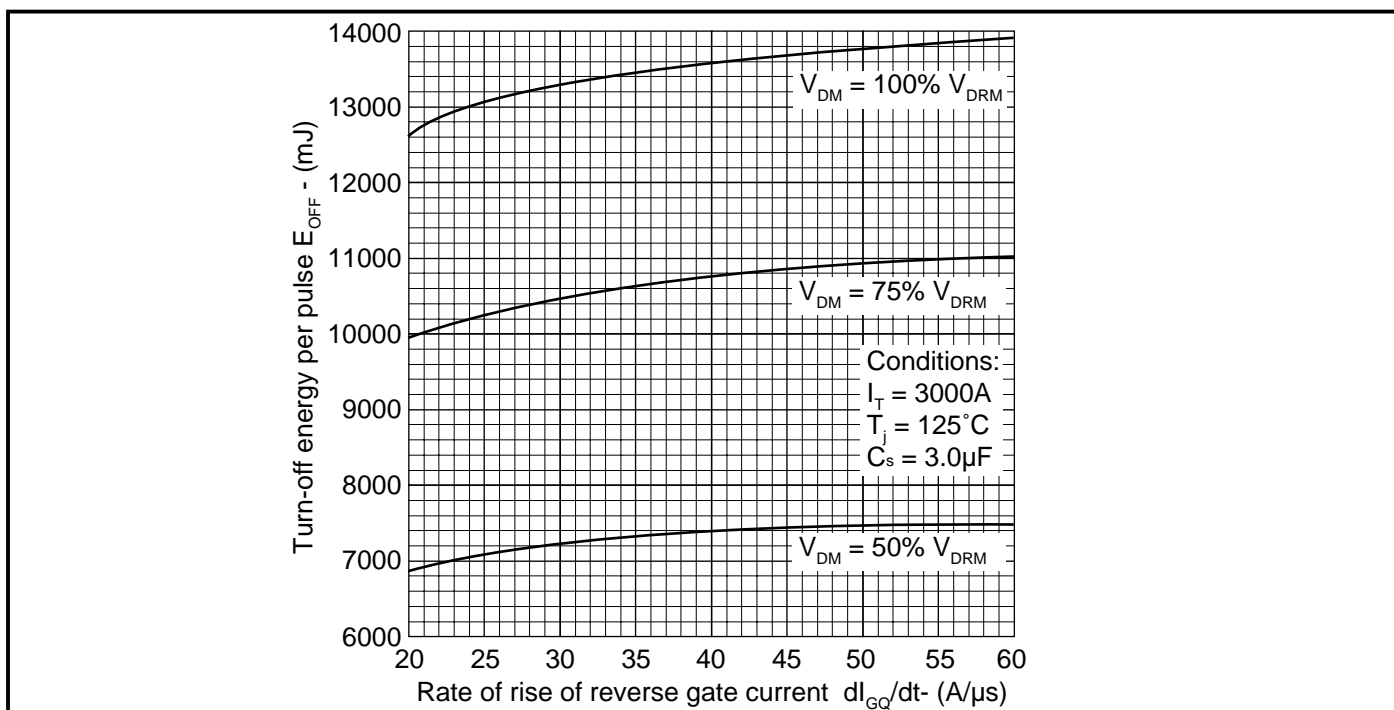

Figure 19. Turn-off energy loss vs rate of rise of reverse gate current

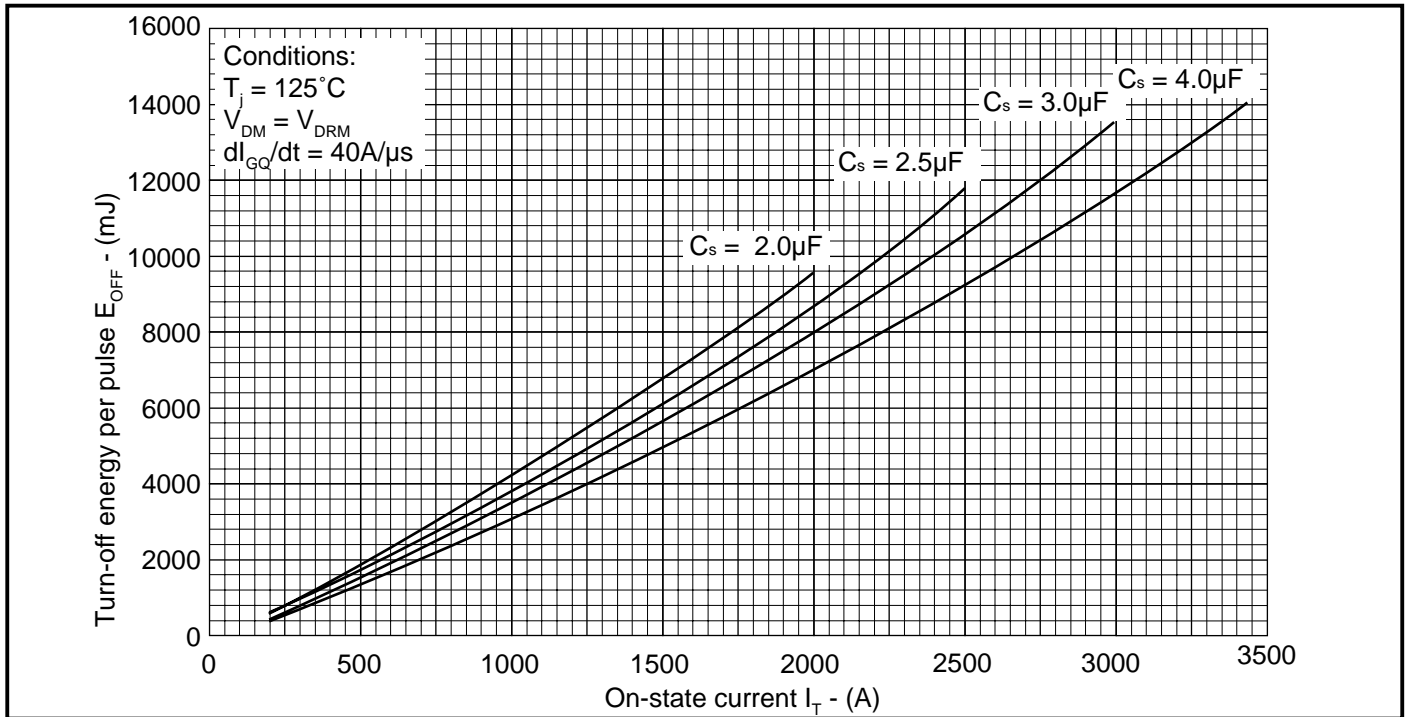

Figure 20. Turn-off energy vs on-state current

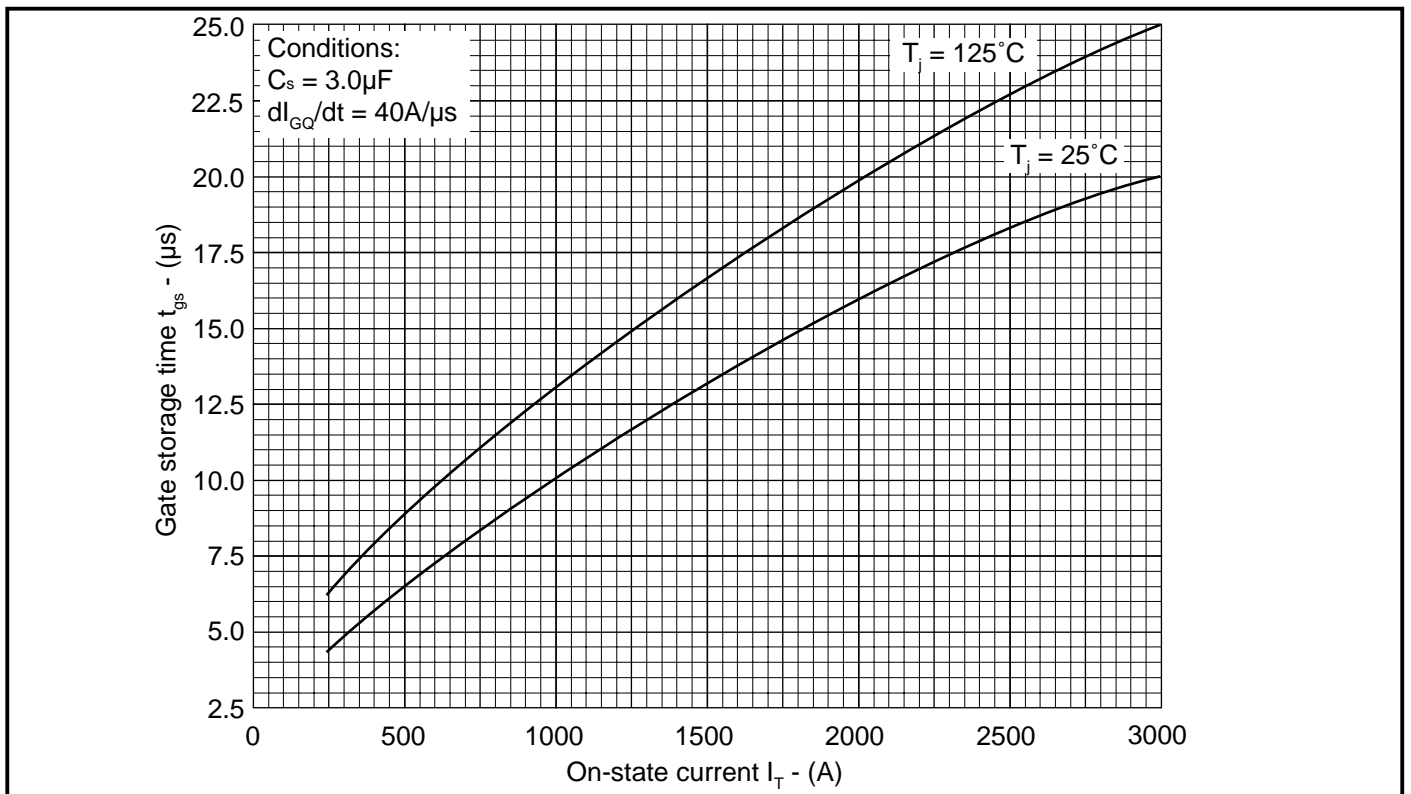

Figure 21. Gate storage time vs on-state current

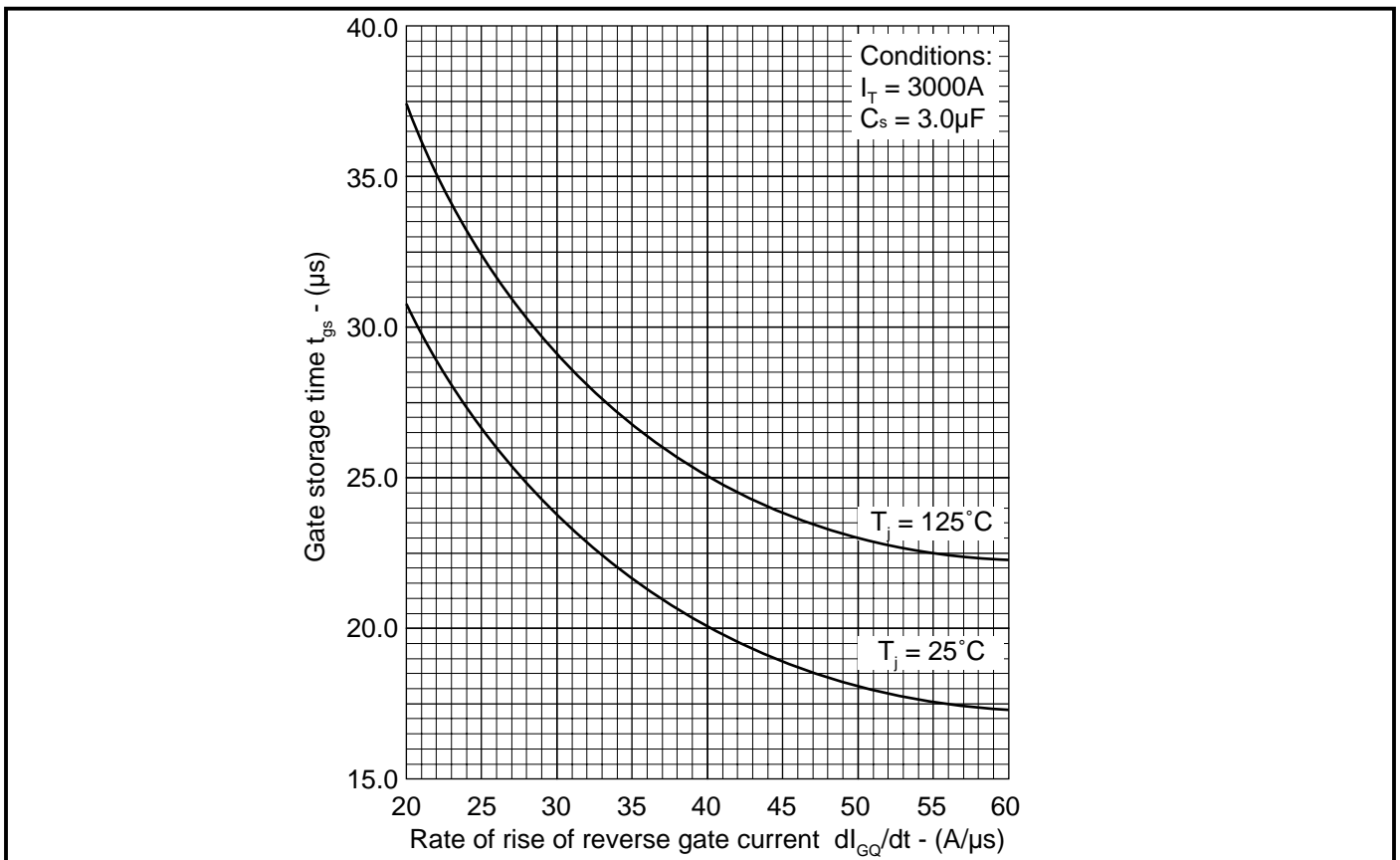

Figure 22. Gate storage time vs rate of rise of reverse gate current

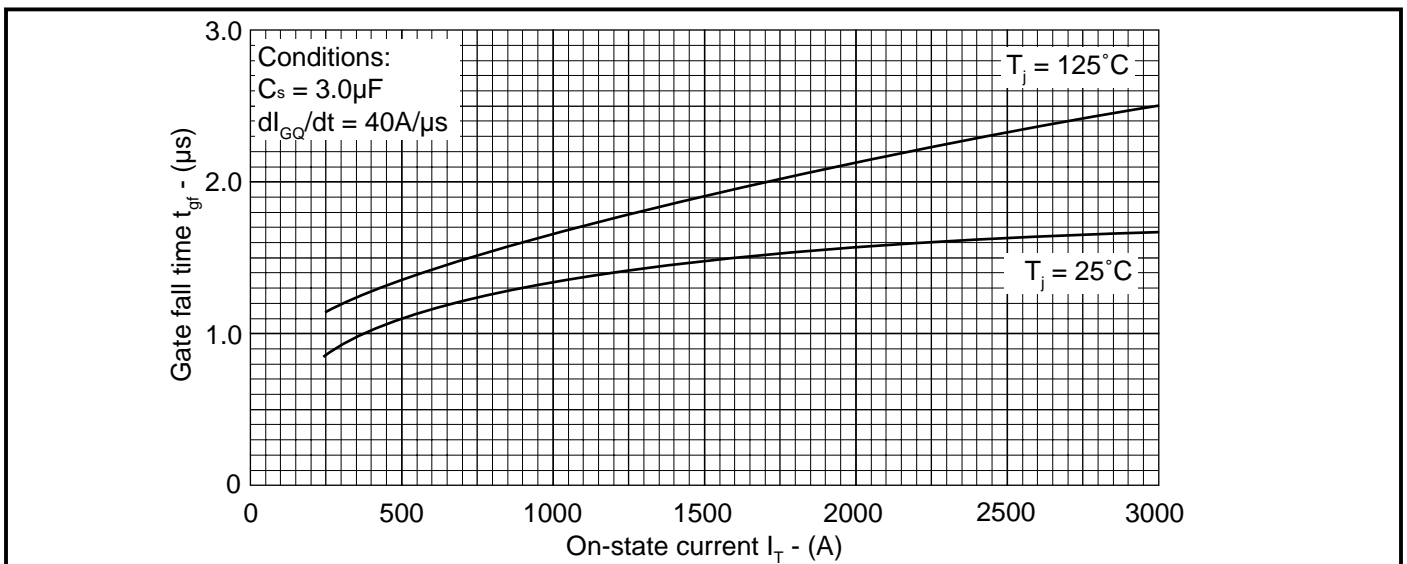

Figure 23. Gate fall time vs on-state current

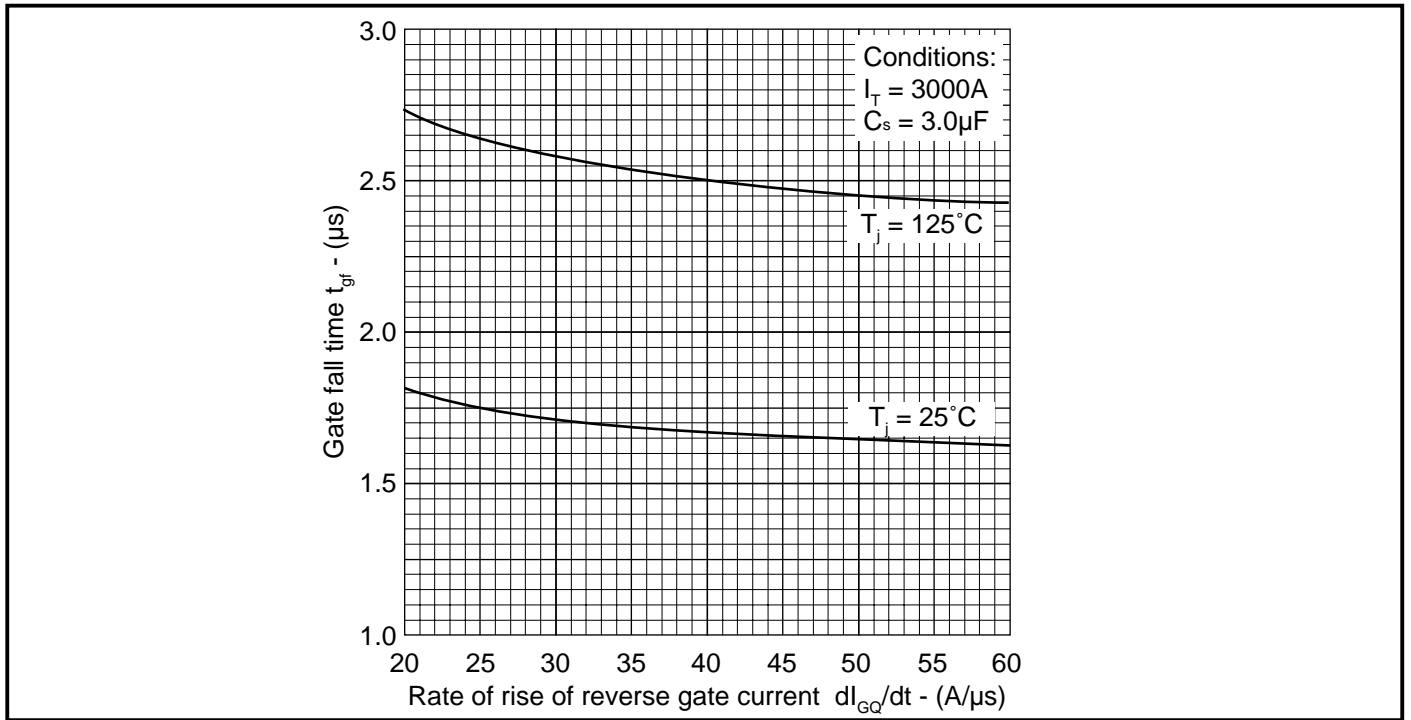

Figure 24. Gate fall time vs rate of rise of reverse gate current

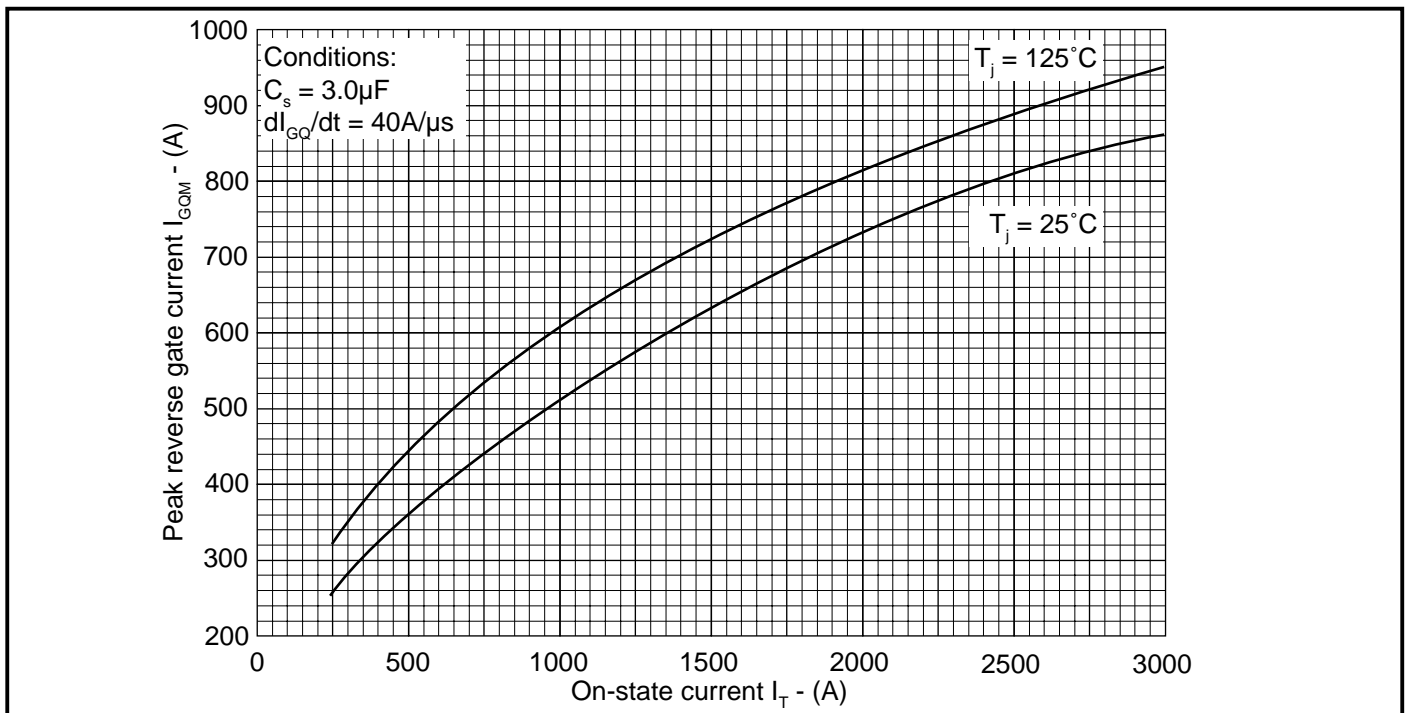

Figure 25. Peak reverse gate current vs on-state current

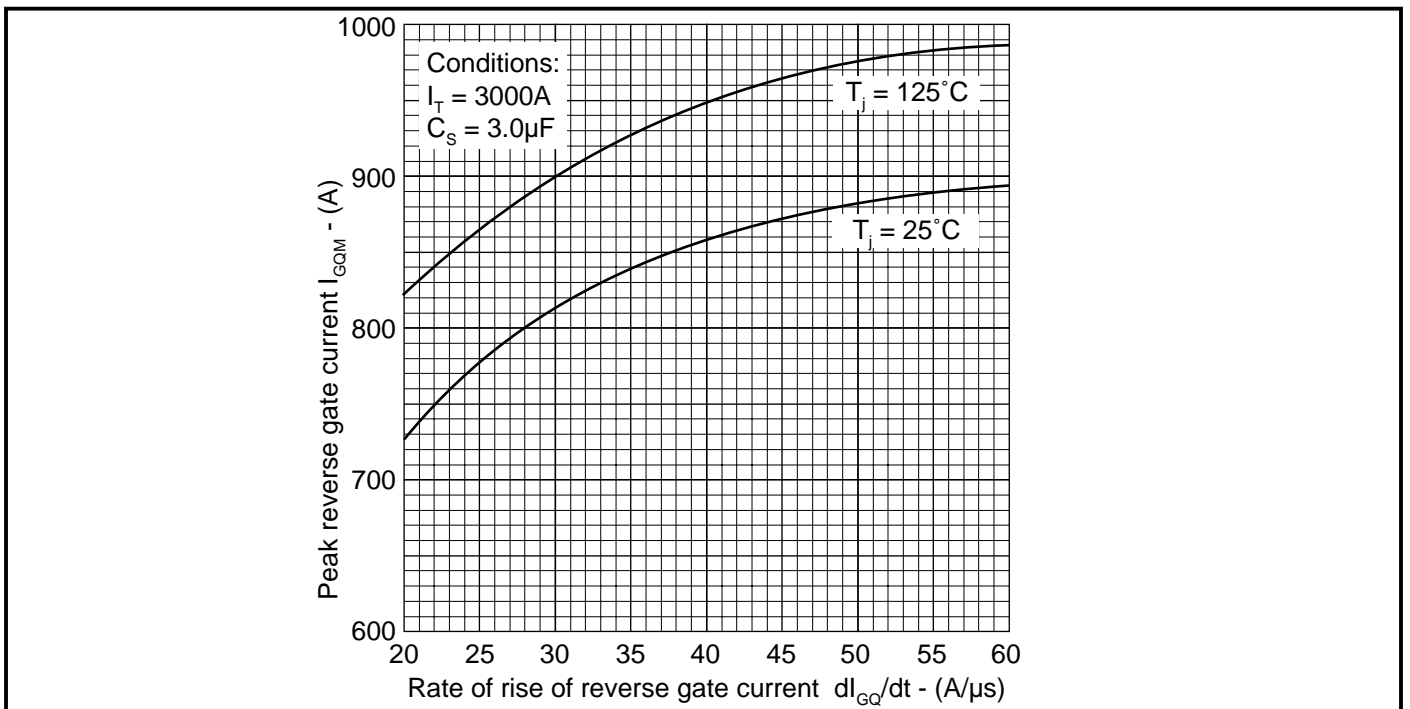

Figure 26. Reverse gate current vs rate of rise of reverse gate current

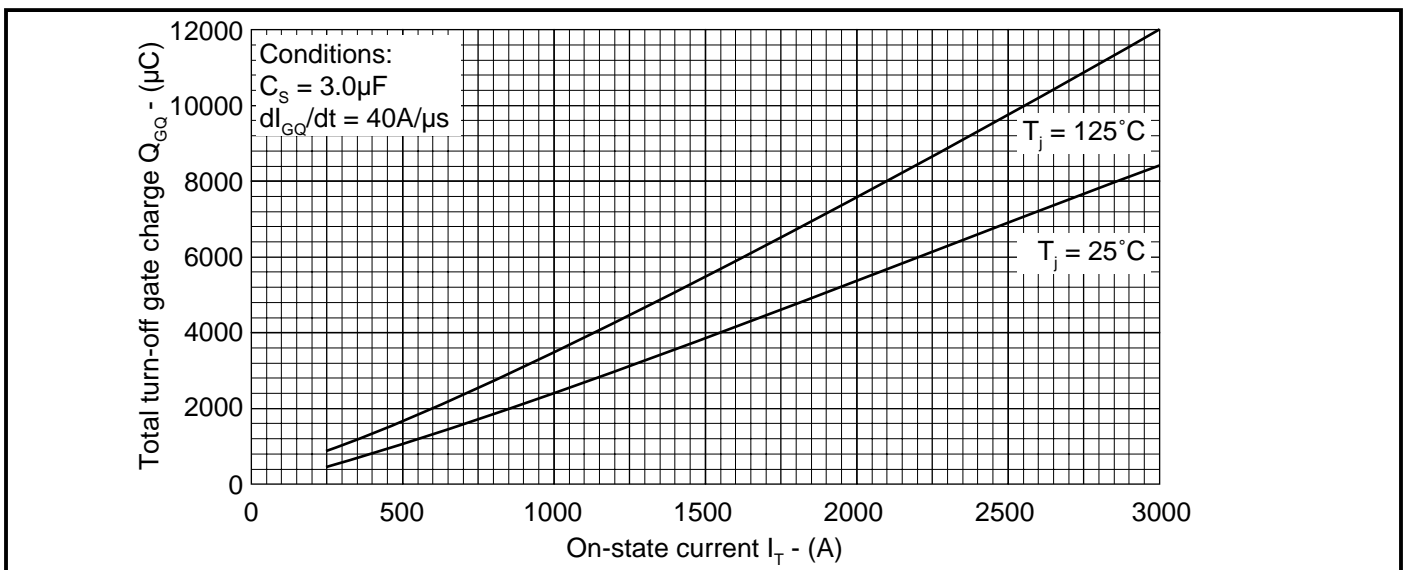

Figure 27. Turn-off gate charge vs on-state current

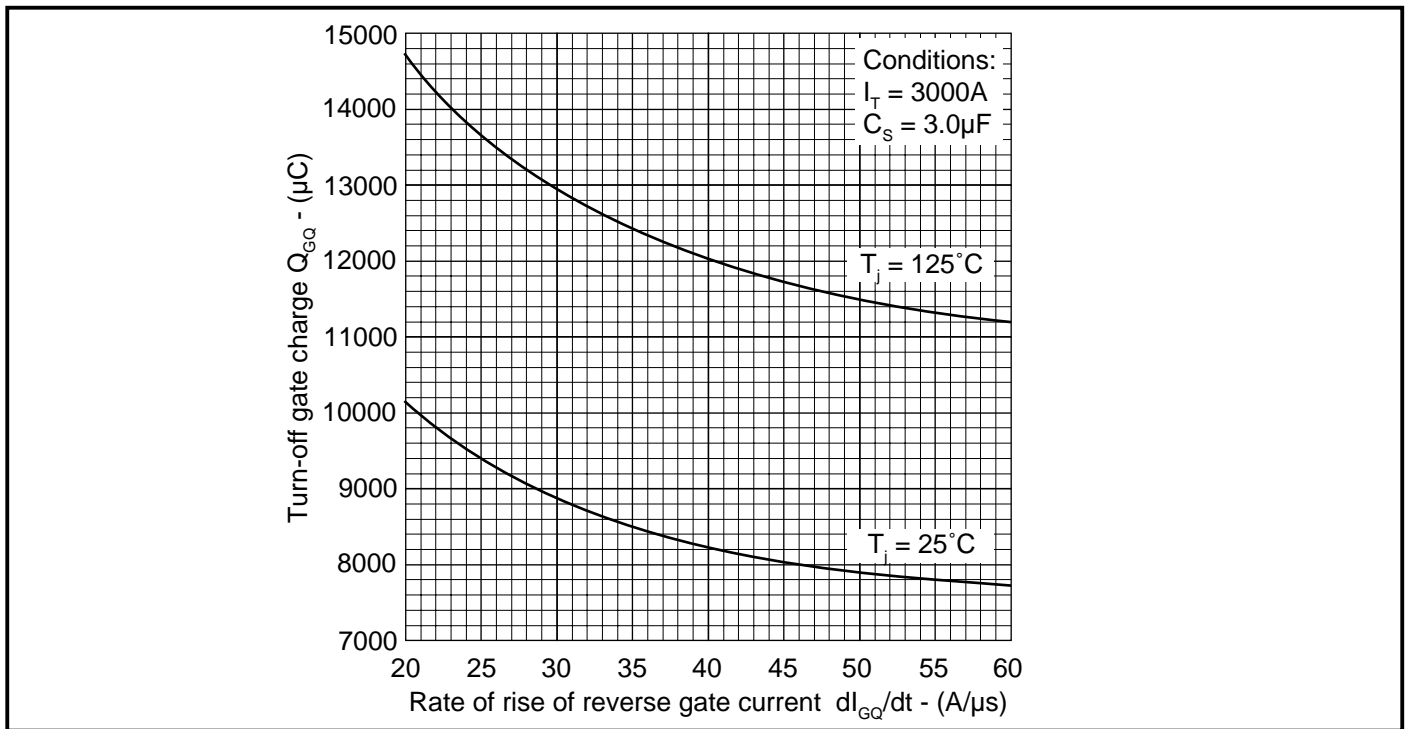

Figure 28. Turn-off gate charge vs rate of rise of reverse gate current

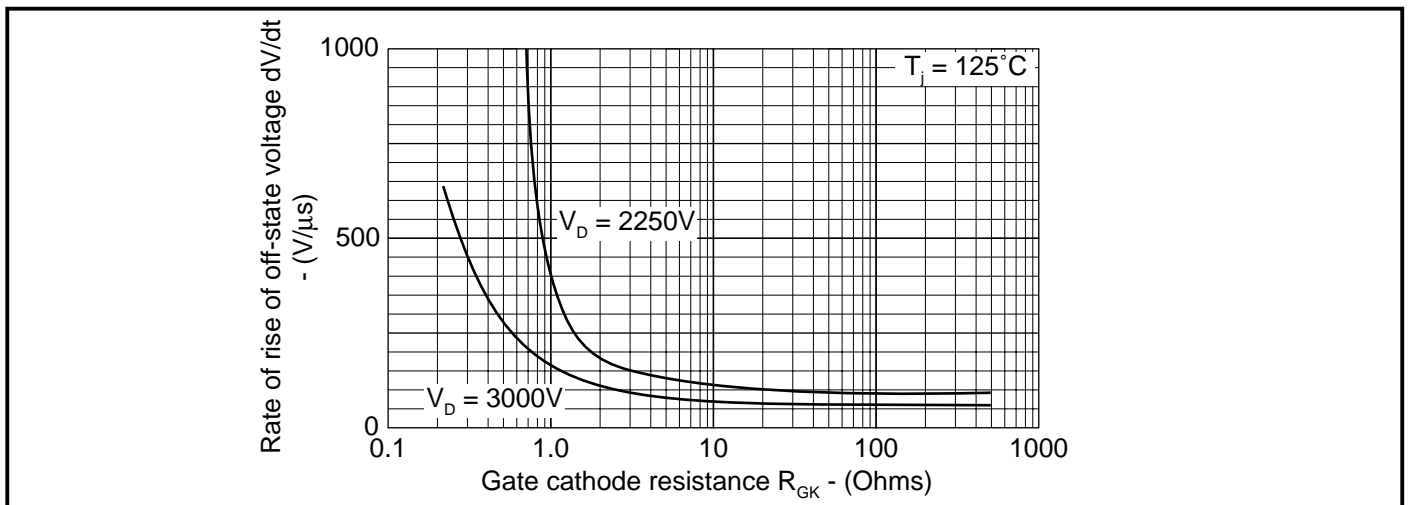
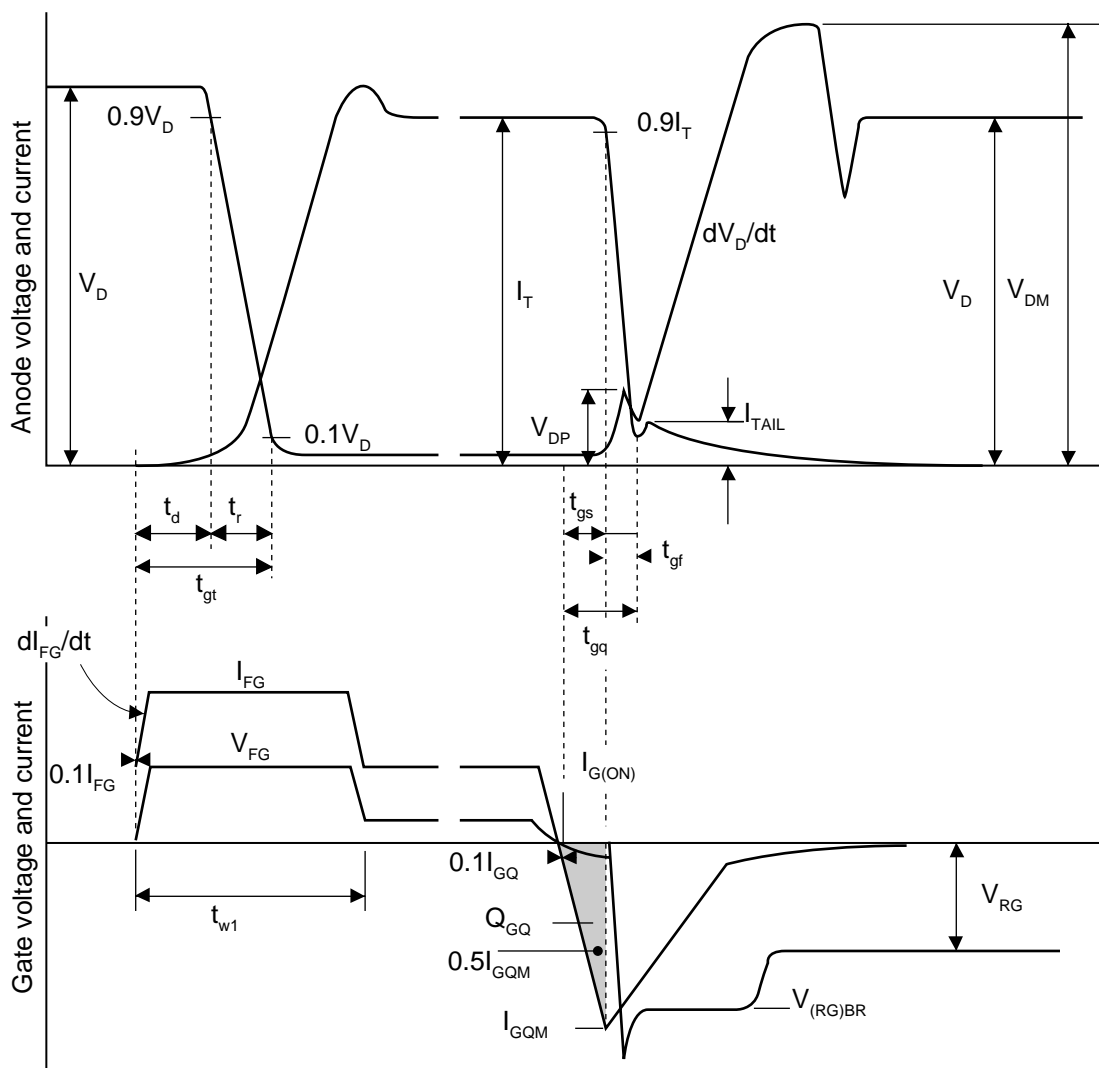

Figure 29. Rate of rise of off-state voltage vs gate cathode resistance



Recommended gate conditions:

- $I_{TCM} = 3000A$
- $I_{FG} = 40A$
- $I_{G(ON)} = 10A$ d.c.
- $t_{w1(min)} = 20\mu s$
- $I_{GQM} = 950A$
- $di_{GQ}/dt = 40A/\mu s$
- $Q_{GQ} = 12000\mu C$
- $V_{RG(min)} = 2V$
- $V_{RG(max)} = 16V$

These are recommended Dynex Semiconductor conditions. Other conditions are permitted

Figure 30. General switching waveforms

DG858BW45

PACKAGE DETAILS

For further package information, please contact Customer Services. All dimensions in mm, unless stated otherwise. DO NOT SCALE.

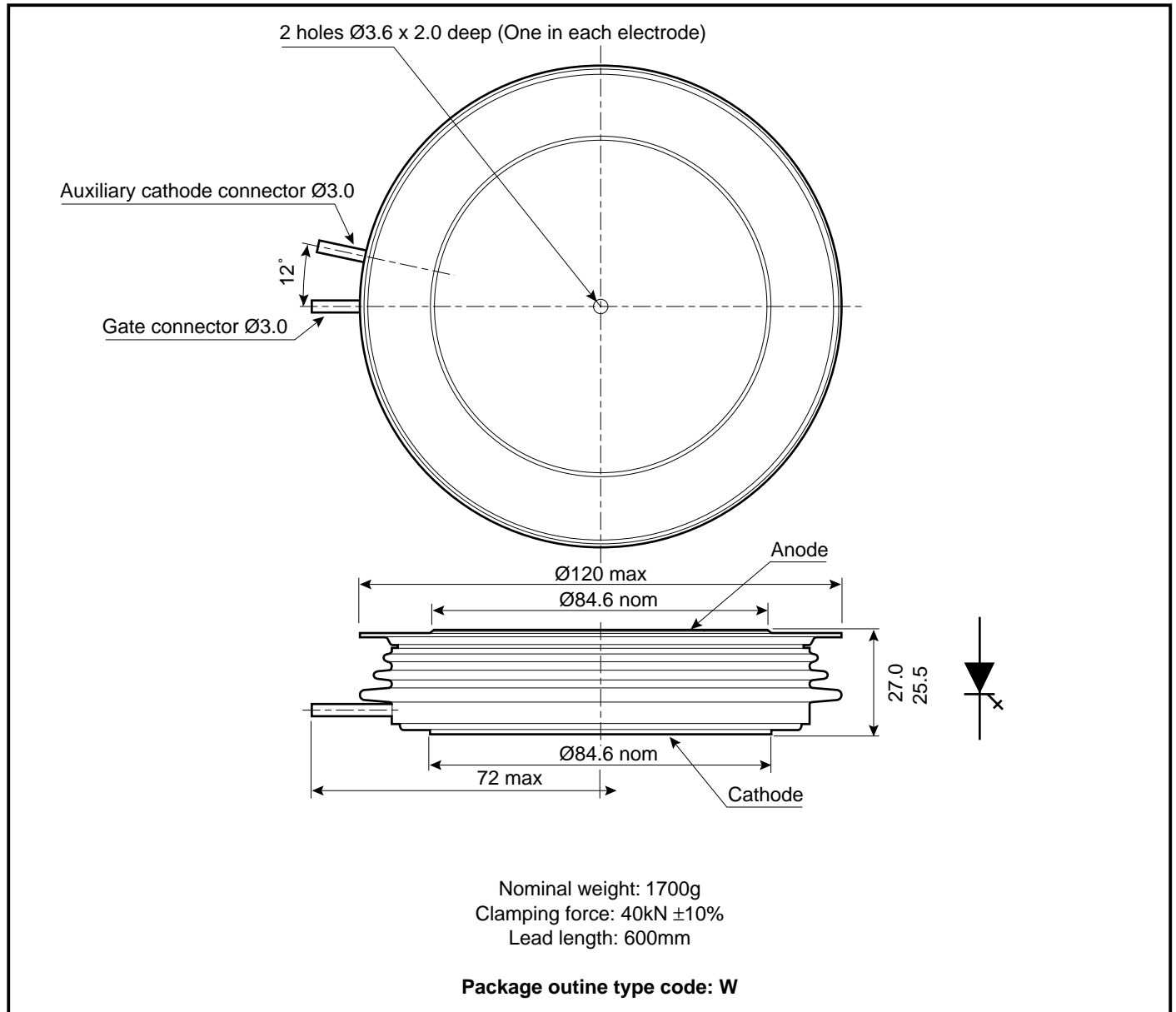

POWER ASSEMBLY CAPABILITY

The Power Assembly group was set up to provide a support service for those customers requiring more than the basic semiconductor, and has developed a flexible range of heatsink and clamping systems in line with advances in device voltages and current capability of our semiconductors.

We offer an extensive range of air and liquid cooled assemblies covering the full range of circuit designs in general use today. The Assembly group offers high quality engineering support dedicated to designing new units to satisfy the growing needs of our customers.

Using the latest CAD methods our team of design and applications engineers aim to provide the Power Assembly Complete Solution (PACs).

HEATSINKS

The Power Assembly group has its own proprietary range of extruded aluminium heatsinks which have been designed to optimise the performance of Dynex semiconductors. Data with respect to air natural, forced air and liquid cooling (with flow rates) is available on request.

For further information on device clamps, heatsinks and assemblies, please contact your nearest sales representative or Customer Services.



<http://www.dynexsemi.com>

e-mail: power_solutions@dynexsemi.com

HEADQUARTERS OPERATIONS
DYNEX SEMICONDUCTOR LTD
Doddington Road, Lincoln.
Lincolnshire. LN6 3LF. United Kingdom.
Tel: +44-(0)1522-500500
Fax: +44-(0)1522-500550

CUSTOMER SERVICE
Tel: +44 (0)1522 502753 / 502901. Fax: +44 (0)1522 500020

SALES OFFICES
Benelux, Italy & Switzerland: Tel: +33 (0)1 64 66 42 17. Fax: +33 (0)1 64 66 42 19.
France: Tel: +33 (0)2 47 55 75 52. Fax: +33 (0)2 47 55 75 59.
Germany, Northern Europe, Spain & Rest Of World: Tel: +44 (0)1522 502753 / 502901.
Fax: +44 (0)1522 500020
North America: Tel: (440) 259-2060. Fax: (440) 259-2059. Tel: (949) 733-3005. Fax: (949) 733-2986.

These offices are supported by Representatives and Distributors in many countries world-wide.
© Dynex Semiconductor 2003 TECHNICAL DOCUMENTATION – NOT FOR RESALE. PRODUCED IN UNITED KINGDOM

Datasheet Annotations:

Dynex Semiconductor annotate datasheets in the top right hand corner of the front page, to indicate product status. The annotations are as follows:-

Target Information: This is the most tentative form of information and represents a very preliminary specification. No actual design work on the product has been started.

Preliminary Information: The product is in design and development. The datasheet represents the product as it is understood but details may change.

Advance Information: The product design is complete and final characterisation for volume production is well in hand.

No Annotation: The product parameters are fixed and the product is available to datasheet specification.

This publication is issued to provide information only which (unless agreed by the Company in writing) may not be used, applied or reproduced for any purpose nor form part of any order or contract nor to be regarded as a representation relating to the products or services concerned. No warranty or guarantee express or implied is made regarding the capability, performance or suitability of any product or service. The Company reserves the right to alter without prior notice the specification, design or price of any product or service. Information concerning possible methods of use is provided as a guide only and does not constitute any guarantee that such methods of use will be satisfactory in a specific piece of equipment. It is the user's responsibility to fully determine the performance and suitability of any equipment using such information and to ensure that any publication or data used is up to date and has not been superseded. These products are not suitable for use in any medical products whose failure to perform may result in significant injury or death to the user. All products and materials are sold and services provided subject to the Company's conditions of sale, which are available on request.

All brand names and product names used in this publication are trademarks, registered trademarks or trade names of their respective owners.