

### FEATURES

- Double Side Cooling
- High Surge Capability

### APPLICATIONS

- Rectification
- Freewheel Diode
- DC Motor Control
- Power Supplies

### VOLTAGE RATINGS

Type Number	Repetitive Peak Reverse Voltage $V_{RRM}$ V	Conditions
DS2907SA52	5200	$V_{RSM} = V_{RRM} + 100V$
DS2907SA50	5000	
DS2907SA48	4800	
DS2907SA46	4600	
DS2907SA44	4400	

Lower voltage grades available

### KEY PARAMETERS

$V_{RRM}$  5200V

$I_{F(AV)}$  4914A

$I_{FSM}$  70000A

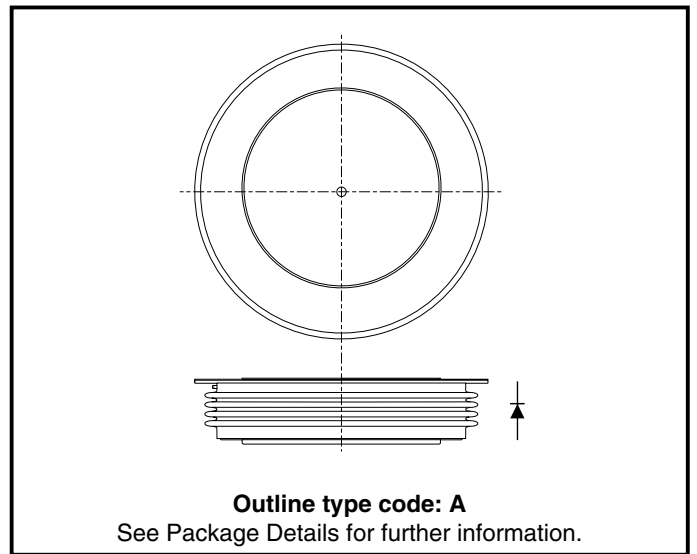

**Fig. 1 Package outline**

### ORDERING INFORMATION

When ordering, select the required part number shown in the Voltage Ratings selection table, e.g.:

#### DS2907SA48

Note: Please use the complete part number when ordering and quote this number in any future correspondence relating to your order.

## CURRENT RATINGS

$T_{case} = 75^{\circ}\text{C}$  unless otherwise stated

Symbol	Parameter	Conditions	Max.	Units
<b>Double Side Cooled</b>				
$I_{F(AV)}$	Mean forward current	Half wave resistive load	4914	A
$I_{F(RMS)}$	RMS value	-	7715	A
$I_F$	Continuous (direct) forward current	-	7150	A
<b>Single Side Cooled (Anode side)</b>				
$I_{F(AV)}$	Mean forward current	Half wave resistive load	3213	A
$I_{F(RMS)}$	RMS value	-	5044	A
$I_F$	Continuous (direct) forward current	-	4407	A

$T_{case} = 100^{\circ}\text{C}$  unless otherwise stated

Symbol	Parameter	Conditions	Max.	Units
<b>Double Side Cooled</b>				
$I_{F(AV)}$	Mean forward current	Half wave resistive load	3768	A
$I_{F(RMS)}$	RMS value	-	5916	A
$I_F$	Continuous (direct) forward current	-	5414	A
<b>Single Side Cooled (Anode side)</b>				
$I_{F(AV)}$	Mean forward current	Half wave resistive load	2433	A
$I_{F(RMS)}$	RMS value	-	3820	A
$I_F$	Continuous (direct) forward current	-	3256	A

**SURGE RATINGS**

Symbol	Parameter	Conditions	Max.	Units
$I_{FSM}$	Surge (non-repetitive) forward current	10ms half sine; $T_{case} = 150^{\circ}C$	70	kA
$I^2t$	$I^2t$ for fusing	$V_R = 0$	$24.5 \times 10^6$	A <sup>2</sup> s

**THERMAL AND MECHANICAL DATA**

Symbol	Parameter	Conditions	Min.	Max.	Units	
$R_{th(j-c)}$	Thermal resistance - junction to case	Double side cooled	dc	-	0.0065	$^{\circ}C/W$
		Single side cooled	Anode dc	-	0.013	$^{\circ}C/W$
			Cathode dc	-	0.013	$^{\circ}C/W$
$R_{th(c-h)}$	Thermal resistance - case to heatsink	Clamping force 83.0kN with mounting compound	Double side	-	0.001	$^{\circ}C/W$
			Single side	-	0.002	$^{\circ}C/W$
$T_{vj}$	Virtual junction temperature	Forward (conducting)		-	160	$^{\circ}C$
		Reverse (blocking)		-	150	$^{\circ}C$
$T_{stg}$	Storage temperature range		-55	150	$^{\circ}C$	
-	Clamping force		75.0	91.0	kN	

**CHARACTERISTICS**

Symbol	Parameter	Conditions	Min.	Max.	Units
$V_{FM}$	Forward voltage	At 3000A peak, $T_{case} = 25^{\circ}C$	-	1.17	V
$I_{RM}$	Peak reverse current	At $V_{RRM}$ , $T_{case} = 150^{\circ}C$	-	200	mA
$V_{TO}$	Threshold voltage	At $T_{vj} = 150^{\circ}C$	-	0.82	V
$r_T$	Slope resistance	At $T_{vj} = 150^{\circ}C$	-	0.111	m $\Omega$

CURVES

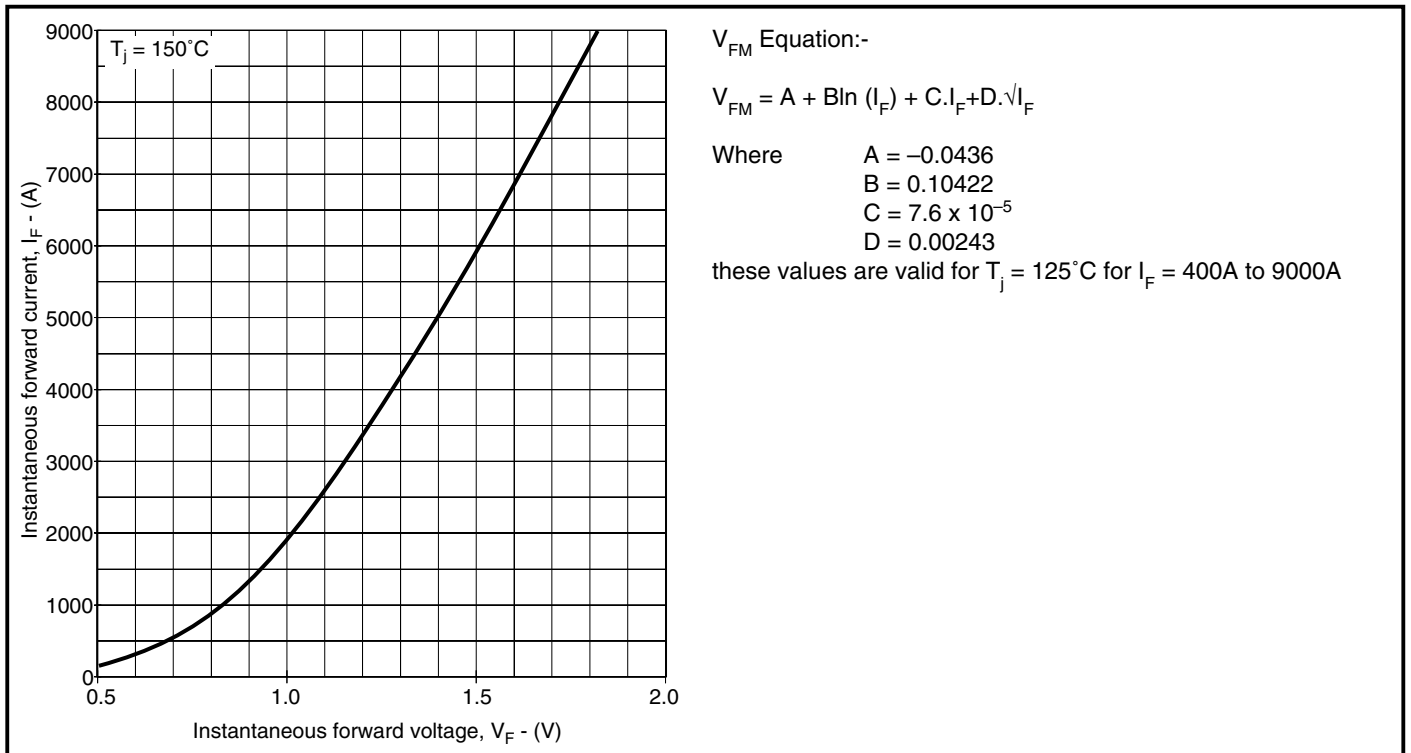

Fig. 2 Maximum (limit) forward characteristics

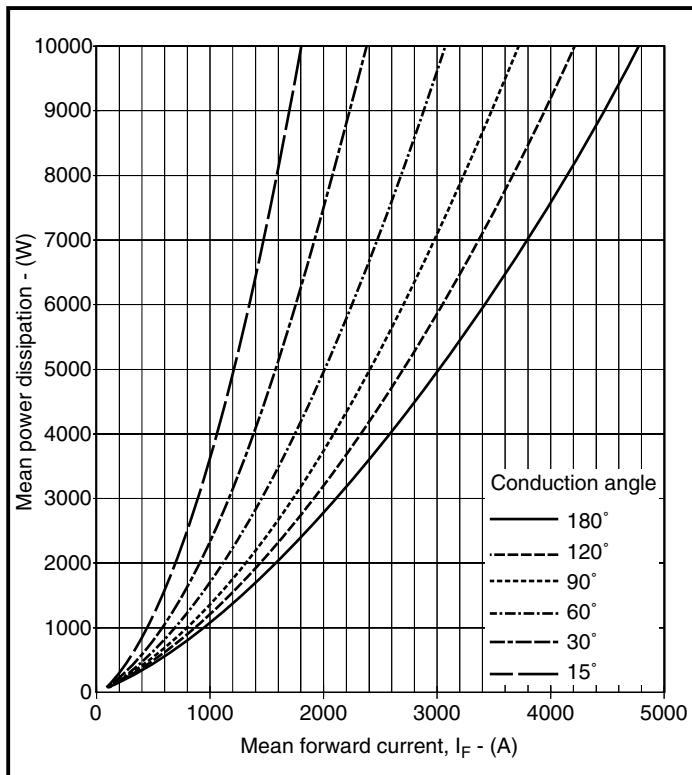

Fig. 3 Power loss curves - sine wave

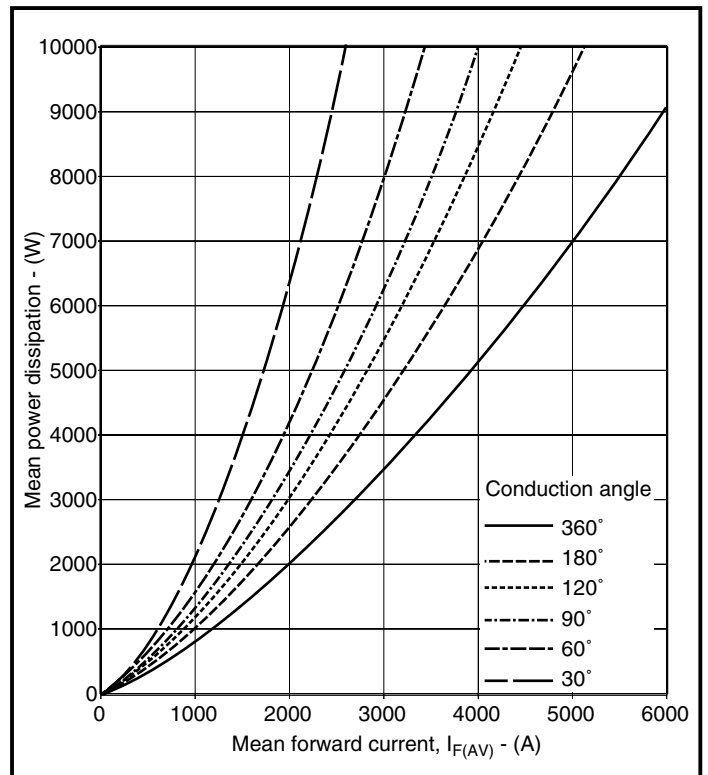
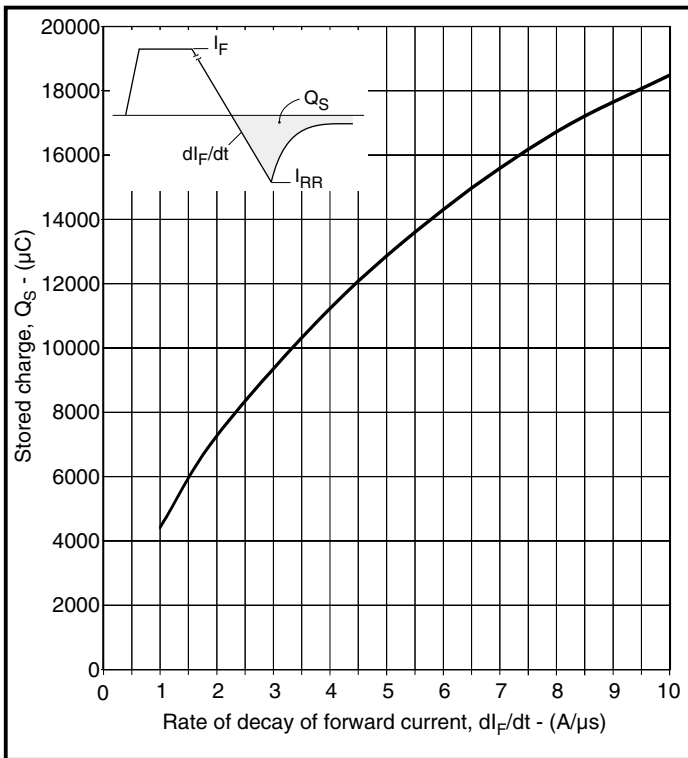
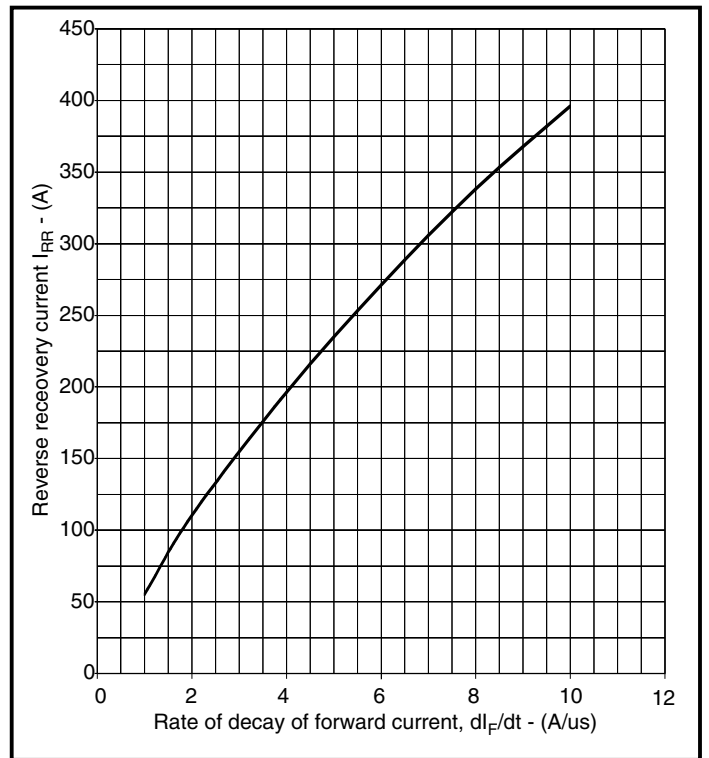

Fig. 4 Power loss curves - square wave



**Fig. 5 Stored charge**



**Fig. 6 Reverse recovery current**

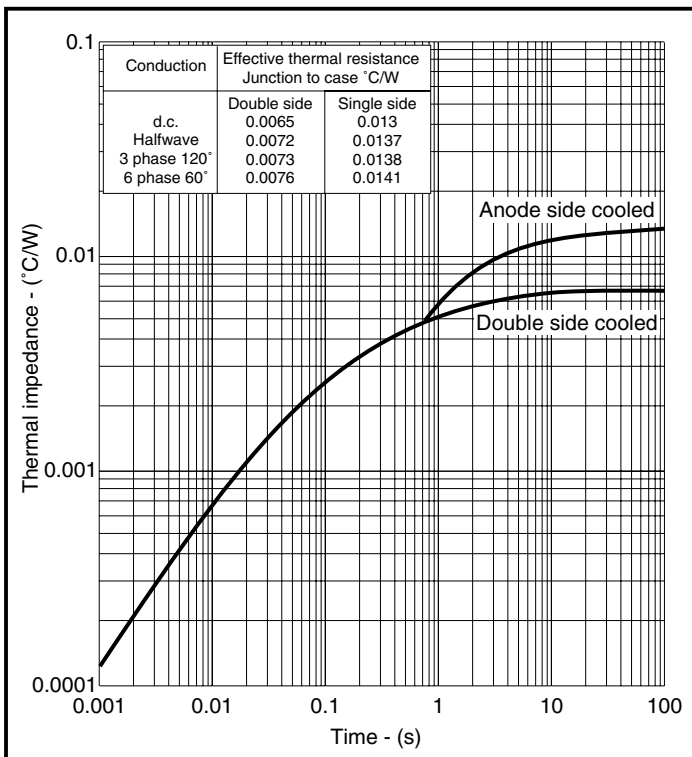

**Fig. 7 Maximum (limit) transient thermal impedance - junction to case - ( $^{\circ}\text{C}/\text{W}$ )**

**PACKAGE DETAILS**

For further package information, please contact Customer Services. All dimensions in mm, unless stated otherwise.  
DO NOT SCALE.

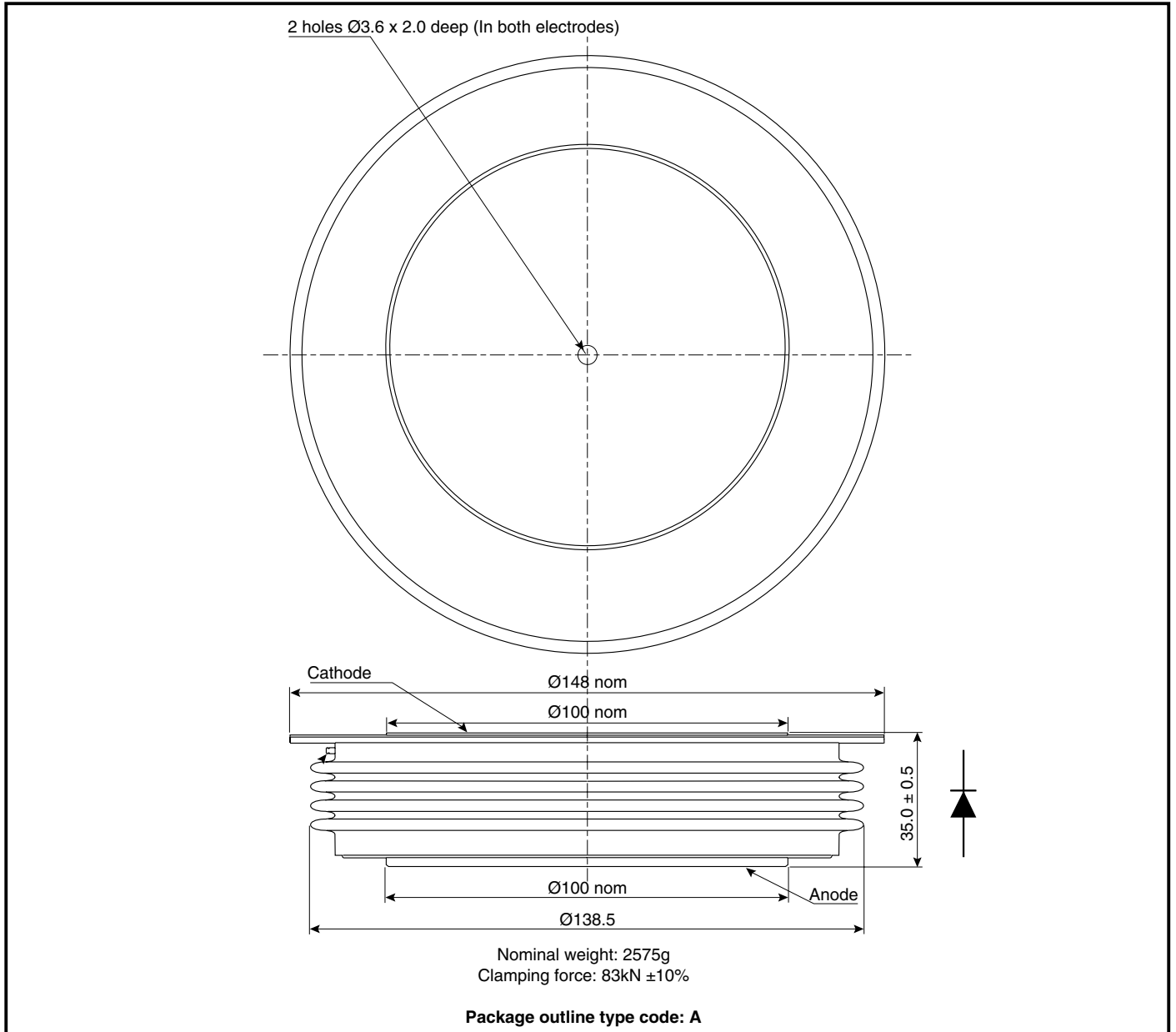

**Fig. 8 Package details**

## POWER ASSEMBLY CAPABILITY

The Power Assembly group was set up to provide a support service for those customers requiring more than the basic semiconductor, and has developed a flexible range of heatsink and clamping systems in line with advances in device voltages and current capability of our semiconductors.

We offer an extensive range of air and liquid cooled assemblies covering the full range of circuit designs in general use today. The Assembly group offers high quality engineering support dedicated to designing new units to satisfy the growing needs of our customers.

Using the latest CAD methods our team of design and applications engineers aim to provide the Power Assembly Complete Solution (PACs).

## HEATSINKS

The Power Assembly group has its own proprietary range of extruded aluminium heatsinks which have been designed to optimise the performance of Dynex semiconductors. Data with respect to air natural, forced air and liquid cooling (with flow rates) is available on request.

For further information on device clamps, heatsinks and assemblies, please contact your nearest sales representative or Customer Services.

Stresses above those listed in this data sheet may cause permanent damage to the device. In extreme conditions, as with all semiconductors, this may include potentially hazardous rupture of the package. Appropriate safety precautions should always be followed.



<http://www.dynexsemi.com>

**e-mail: [power\\_solutions@dynexsemi.com](mailto:power_solutions@dynexsemi.com)**

**HEADQUARTERS OPERATIONS**  
**DYNEX SEMICONDUCTOR LTD**  
Doddington Road, Lincoln.  
Lincolnshire. LN6 3LF. United Kingdom.  
Tel: +44-(0)1522-500500  
Fax: +44-(0)1522-500550

**CUSTOMER SERVICE**  
Tel: +44 (0)1522 502753 / 502901. Fax: +44 (0)1522 500020

**SALES OFFICES**  
**Benelux, Italy & Switzerland:** Tel: +33 (0)1 60 69 32 36. Fax: +33 (0)1 60 69 31 97.  
**France:** Tel: +33 (0)2 47 55 75 53. Fax: +33 (0)2 47 55 75 59. Tel: +33 (0)1 60 69 32 36. Fax: +33 (0)1 60 69 31 97  
**Germany, Northern Europe, Spain & Rest Of World:** Tel: +44 (0)1522 502753 / 502901.  
Fax: +44 (0)1522 500020  
**North America:** Tel: (440) 259-2060. Fax: (440) 259-2059. Tel: (949) 733-3005. Fax: (949) 733-2986.

These offices are supported by Representatives and Distributors in many countries world-wide.  
© Dynex Semiconductor 2003 TECHNICAL DOCUMENTATION – NOT FOR RESALE. PRODUCED IN UNITED KINGDOM

This publication is issued to provide information only which (unless agreed by the Company in writing) may not be used, applied or reproduced for any purpose nor form part of any order or contract nor to be regarded as a representation relating to the products or services concerned. No warranty or guarantee express or implied is made regarding the capability, performance or suitability of any product or service. The Company reserves the right to alter without prior notice the specification, design or price of any product or service. Information concerning possible methods of use is provided as a guide only and does not constitute any guarantee that such methods of use will be satisfactory in a specific piece of equipment. It is the user's responsibility to fully determine the performance and suitability of any equipment using such information and to ensure that any publication or data used is up to date and has not been superseded. These products are not suitable for use in any medical products whose failure to perform may result in significant injury or death to the user. All products and materials are sold and services provided subject to the Company's conditions of sale, which are available on request.

All brand names and product names used in this publication are trademarks, registered trademarks or trade names of their respective owners.