

FEATURES

- Double Side Cooling
- High Surge Capability

APPLICATIONS

- High Power Drives
- High Voltage Power Supplies
- Static Switches

VOLTAGE RATINGS

Part and Ordering Number	Repetitive Peak Voltages V_{DRM} and V_{RRM} V	Conditions
DCR490J65	6500	$T_{vj} = -40^{\circ}C$ to $125^{\circ}C$, $I_{DRM} = I_{RRM} = 100mA$, $V_{DRM}, V_{RRM} t_p = 10ms$, $V_{DSM} \& V_{RSM} =$ $V_{DRM} \& V_{RRM} + 100V$ respectively
DCR490J62	6200	
DCR490J58	5800	

Lower voltage grades available.

ORDERING INFORMATION

When ordering, select the required part number shown in the Voltage Ratings selection table.

For example:

DCR490J65

Note: Please use the complete part number when ordering and quote this number in any future correspondence relating to your order.

KEY PARAMETERS

V_{DRM}	6500V
$I_{T(AV)}$	490A
I_{TSM}	6600A
dV/dt^*	1500V/μs
dI/dt	200A/μs

* Higher dV/dt selections available

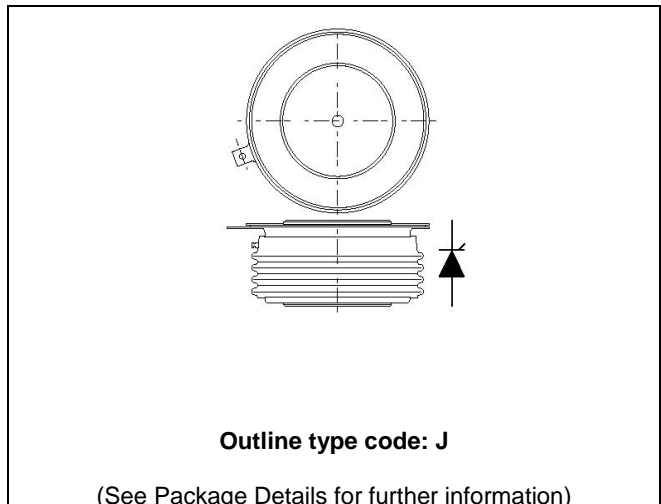

Fig. 1 Package outline

CURRENT RATINGS

$T_{case} = 60^{\circ}C$ unless stated otherwise

Symbol	Parameter	Test Conditions	Max.	Units
Double Side Cooled				
$I_{T(AV)}$	Mean on-state current	Half wave resistive load	490	A
$I_{T(RMS)}$	RMS value	-	770	A
I_T	Continuous (direct) on-state current	-	730	A

SURGE RATINGS

Symbol	Parameter	Test Conditions	Max.	Units
I_{TSM}	Surge (non-repetitive) on-state current	10ms half sine, $T_{case} = 125^{\circ}C$	6.6	kA
I^2t	I^2t for fusing	$V_R = 0$	0.22	MA ² s

THERMAL AND MECHANICAL RATINGS

Symbol	Parameter	Test Conditions	Min.	Max.	Units	
$R_{th(j-c)}$	Thermal resistance – junction to case	Double side cooled	DC	-	0.0379	$^{\circ}C/W$
		Single side cooled	Anode DC	-	0.0745	$^{\circ}C/W$
			Cathode DC	-	0.0797	$^{\circ}C/W$
$R_{th(c-h)}$	Thermal resistance – case to heatsink	Clamping force 11.5kN (with mounting compound)	Double side	-	0.0072	$^{\circ}C/W$
			Single side	-	.0144	$^{\circ}C/W$
T_{vj}	Virtual junction temperature	On-state (conducting)	-	135	$^{\circ}C$	
		Reverse (blocking)	-	125	$^{\circ}C$	
T_{stg}	Storage temperature range		-55	125	$^{\circ}C$	
F_m	Clamping force		10	13	kN	

DYNAMIC CHARACTERISTICS

Symbol	Parameter	Test Conditions	Min.	Max.	Units	
I_{RRM}/I_{DRM}	Peak reverse and off-state current	At V_{RRM}/V_{DRM} , $T_{case} = 125^{\circ}C$	-	100	mA	
dV/dt	Max. linear rate of rise of off-state voltage	To 67% V_{DRM} , $T_j = 125^{\circ}C$, gate open	-	1500	V/ μs	
di/dt	Rate of rise of on-state current	From 67% V_{DRM} to $2x I_{T(AV)}$	Repetitive 50Hz	-	100	A/ μs
		Gate source 30V, 10 Ω , $t_r < 0.5\mu s$, $T_j = 125^{\circ}C$	Non-repetitive	-	200	A/ μs
$V_{T(TO)}$	Threshold voltage – Low level	50A to 400A at $T_{case} = 125^{\circ}C$	-	0.912	V	
	Threshold voltage – High level	400A to 1600A at $T_{case} = 125^{\circ}C$	-	1.108	V	
r_T	On-state slope resistance – Low level	50A to 400A at $T_{case} = 125^{\circ}C$	-	2.157	m Ω	
	On-state slope resistance – High level	400A to 1600A at $T_{case} = 125^{\circ}C$	-	1.647	m Ω	
t_{gd}	Delay time	$V_D = 67\% V_{DRM}$, gate source 30V, 10 Ω $t_r = 0.5\mu s$, $T_j = 25^{\circ}C$	TBD	TBD	μs	
t_q	Turn-off time	$T_j = 125^{\circ}C$, $V_R = 200V$, $di/dt = 5A/\mu s$, $dV_{DR}/dt = 20V/\mu s$ linear	750	1600	μs	
Q_s	Stored charge	$I_T = 2000A$, $T_j = 125^{\circ}C$, $di/dt = 5A/\mu s$,	1600	2600	μC	
I_L	Latching current	$T_j = 25^{\circ}C$, $V_B = 5V$	TBD	TBD	mA	
I_H	Holding current	$T_j = 25^{\circ}C$, $R_{G-K} = \infty$, $I_{TM} = 500A$, $I_T = 5A$	TBD	TBD	mA	

GATE TRIGGER CHARACTERISTICS AND RATINGS

Symbol	Parameter	Test Conditions	Max.	Units
V _{GT}	Gate trigger voltage	V _{DRM} = 5V, T _{case} = 25° C	1.5	V
V _{GD}	Gate non-trigger voltage	At V _{DRM} , T _{case} = 125° C	TBD	V
I _{GT}	Gate trigger current	V _{DRM} = 5V, T _{case} = 25° C	250	mA
I _{GD}	Gate non-trigger current	V _{DRM} = 5V, T _{case} = 25° C	TBD	mA

CURVES

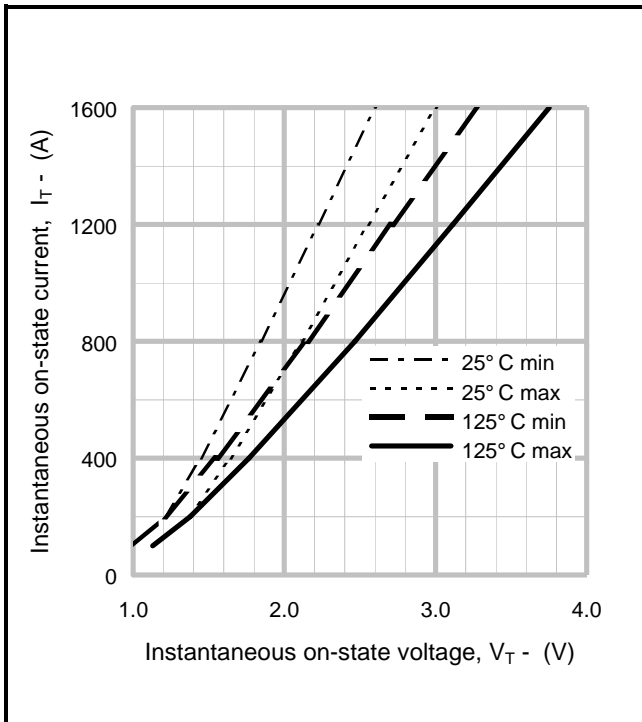

Fig.2 Maximum & minimum on-state characteristics

V_{TM} EQUATION

$$V_{TM} = A + B \ln(I_T) + C \cdot I_T + D \cdot \sqrt{I_T}$$

Where A = 0.542452
 B = 0.065613
 C = 0.001318
 D = 0.015356

these values are valid for T_j = 125° C for I_T 50A to 1600A

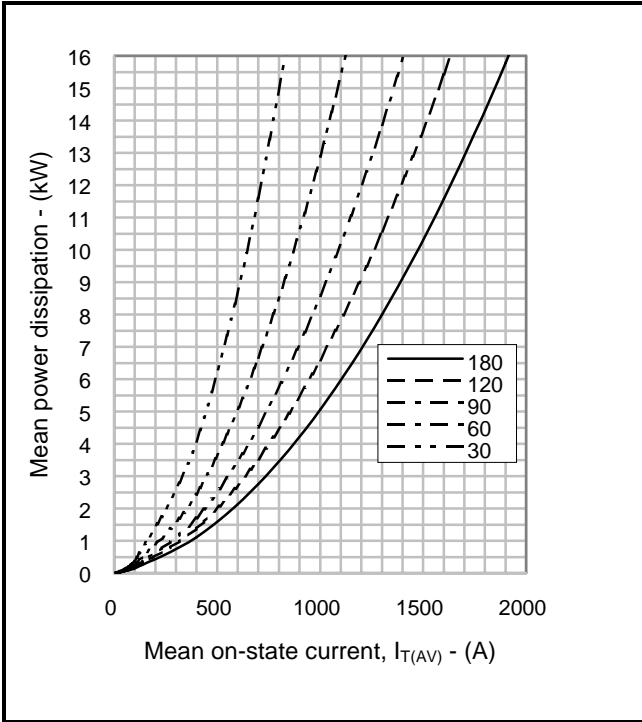

Fig.3 On-state power dissipation – sine wave

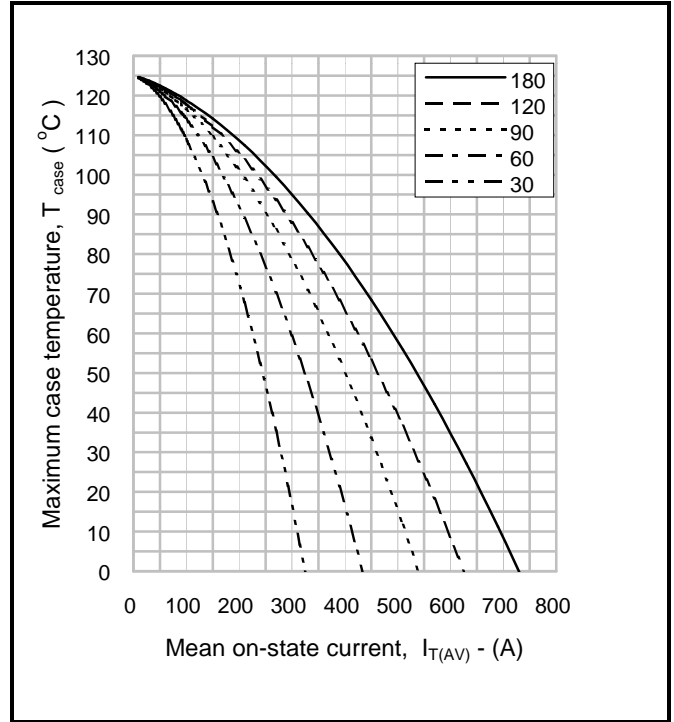

Fig.4 Maximum permissible case temperature, double side cooled – sine wave

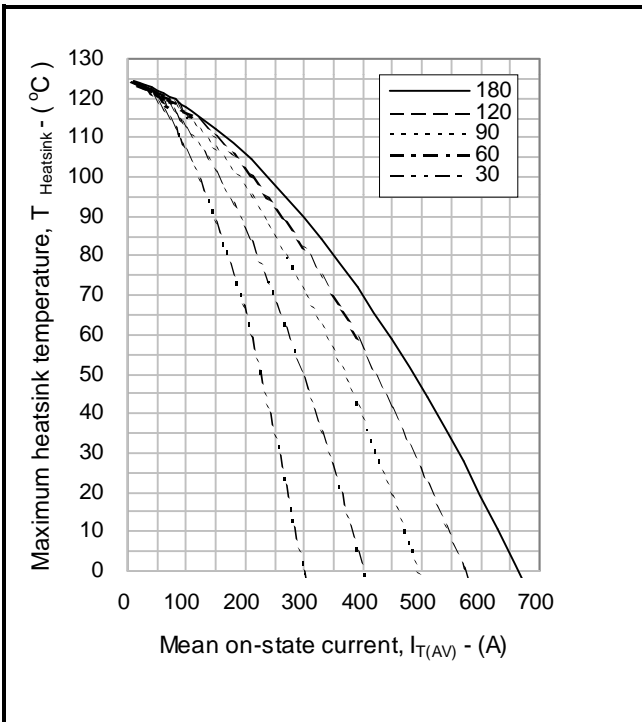

Fig.5 Maximum permissible heatsink temperature, double side cooled – sine wave

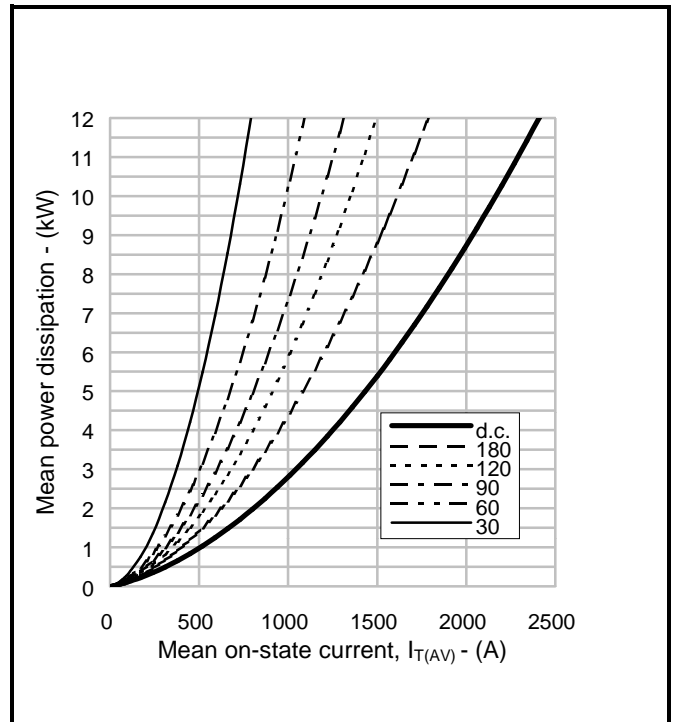

Fig.6 On-state power dissipation – rectangular wave

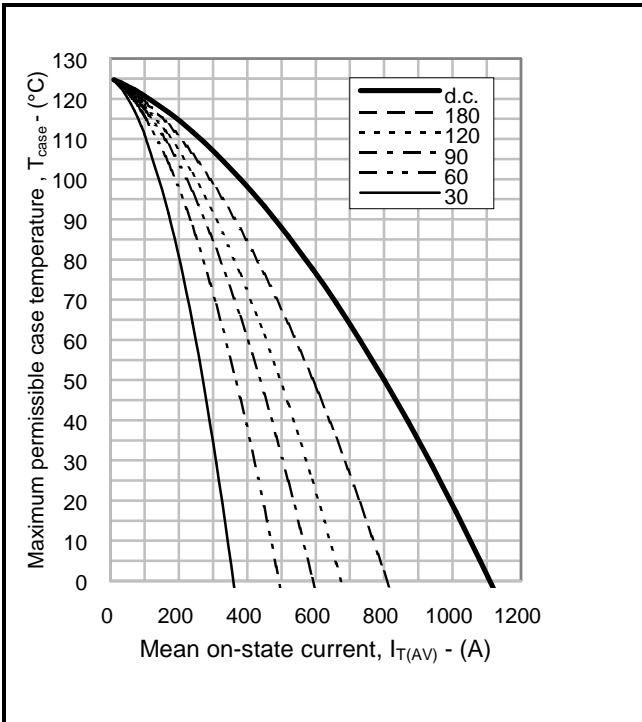

Fig.7 Maximum permissible case temperature, double side cooled – rectangular wave

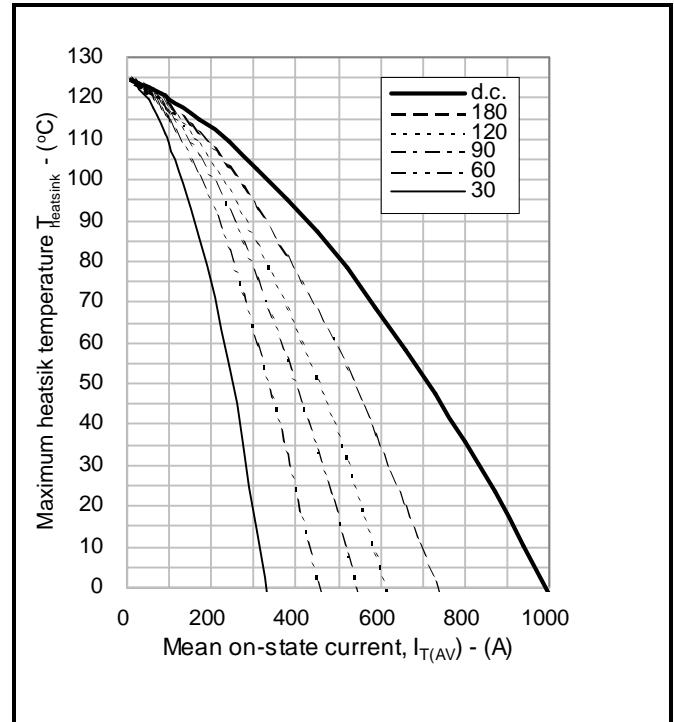

Fig.8 Maximum permissible heatsink temperature, double side cooled – rectangular wave

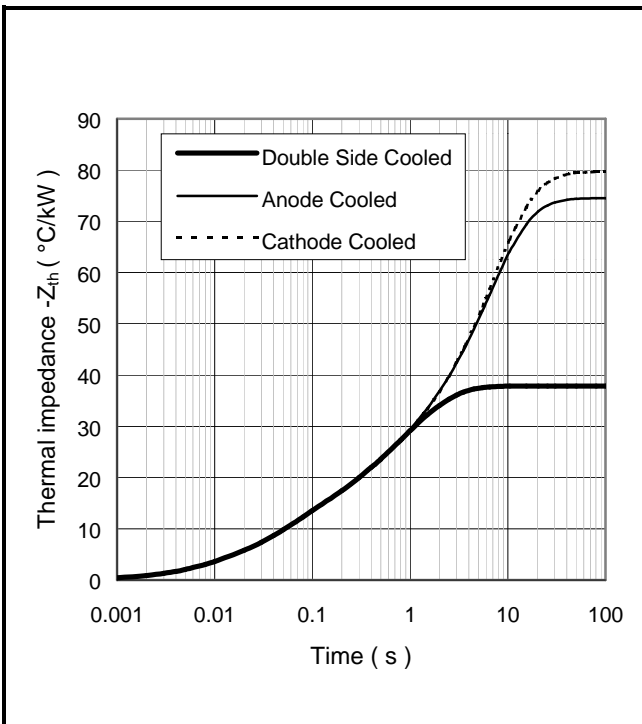

Fig.9 Maximum (limit) transient thermal impedance – junction to case (° C/kW)

		1	2	3	4
Double side cooled	R _i (°C/kW)	2.4256	9.3503	10.6963	15.3758
	T _i (s)	0.0087759	0.053099	0.4497246	1.395
Anode side cooled	R _i (°C/kW)	2.8091	9.5576	11.3564	50.6136
	T _i (s)	0.0097443	0.0591913	0.4759179	6.5548
Cathode side cooled	R _i (°C/kW)	2.9507	9.4031	11.0771	56.0405
	T _i (s)	0.0100391	0.0606056	0.4732916	7.228

$$Z_{th} = \sum [R_i \times (1 - \exp. (-t/t_i))] \quad [1]$$

ΔR_{th(j-c)} Conduction

Tables show the increments of thermal resistance R_{th(j-c)} when the device operates at conduction angles other than d.c.

Double side cooling			Anode Side Cooling			Cathode Sided Cooling		
θ°	ΔZ _{th} (z)		θ°	ΔZ _{th} (z)		θ°	ΔZ _{th} (z)	
	sine.	rect.		sine.	rect.		sine.	rect.
180	4.43	3.01	180	4.39	2.99	180	4.37	2.98
120	5.13	4.30	120	5.07	4.26	120	5.05	4.25
90	5.89	5.03	90	5.81	4.97	90	5.79	4.96
60	6.58	5.81	60	6.48	5.74	60	6.45	5.72
30	7.12	6.67	30	7.00	6.57	30	6.97	6.54
15	7.36	7.13	15	7.24	7.01	15	7.20	6.98

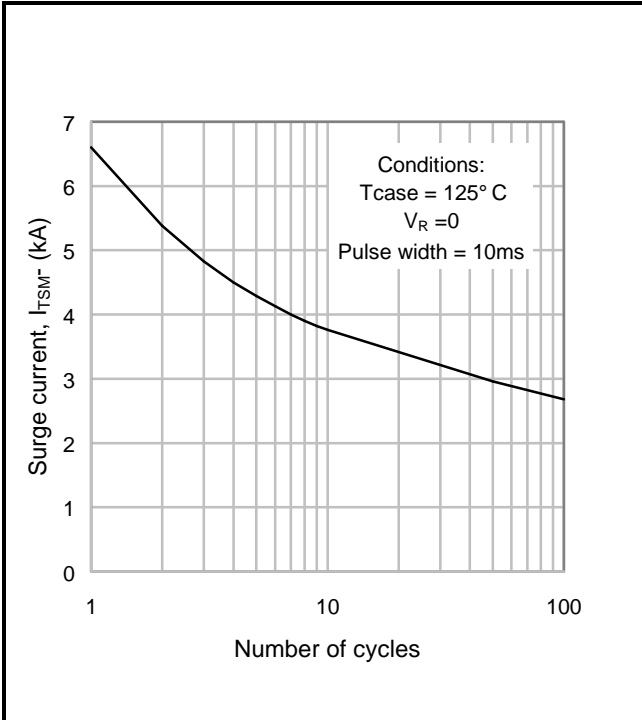

Fig.10 Multi-cycle surge current

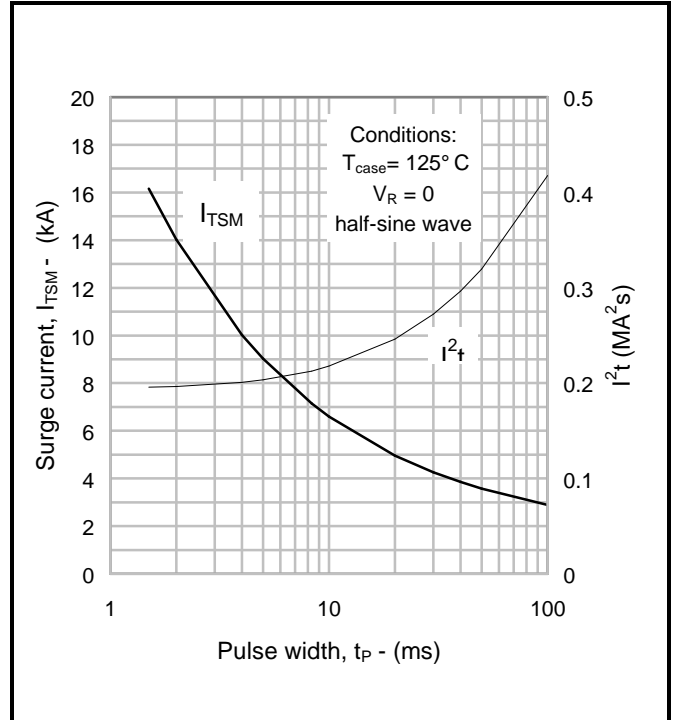

Fig.11 Single-cycle surge current

PACKAGE DETAILS

For further package information, please contact Customer Services. All dimensions in mm, unless stated otherwise. DO NOT SCALE.

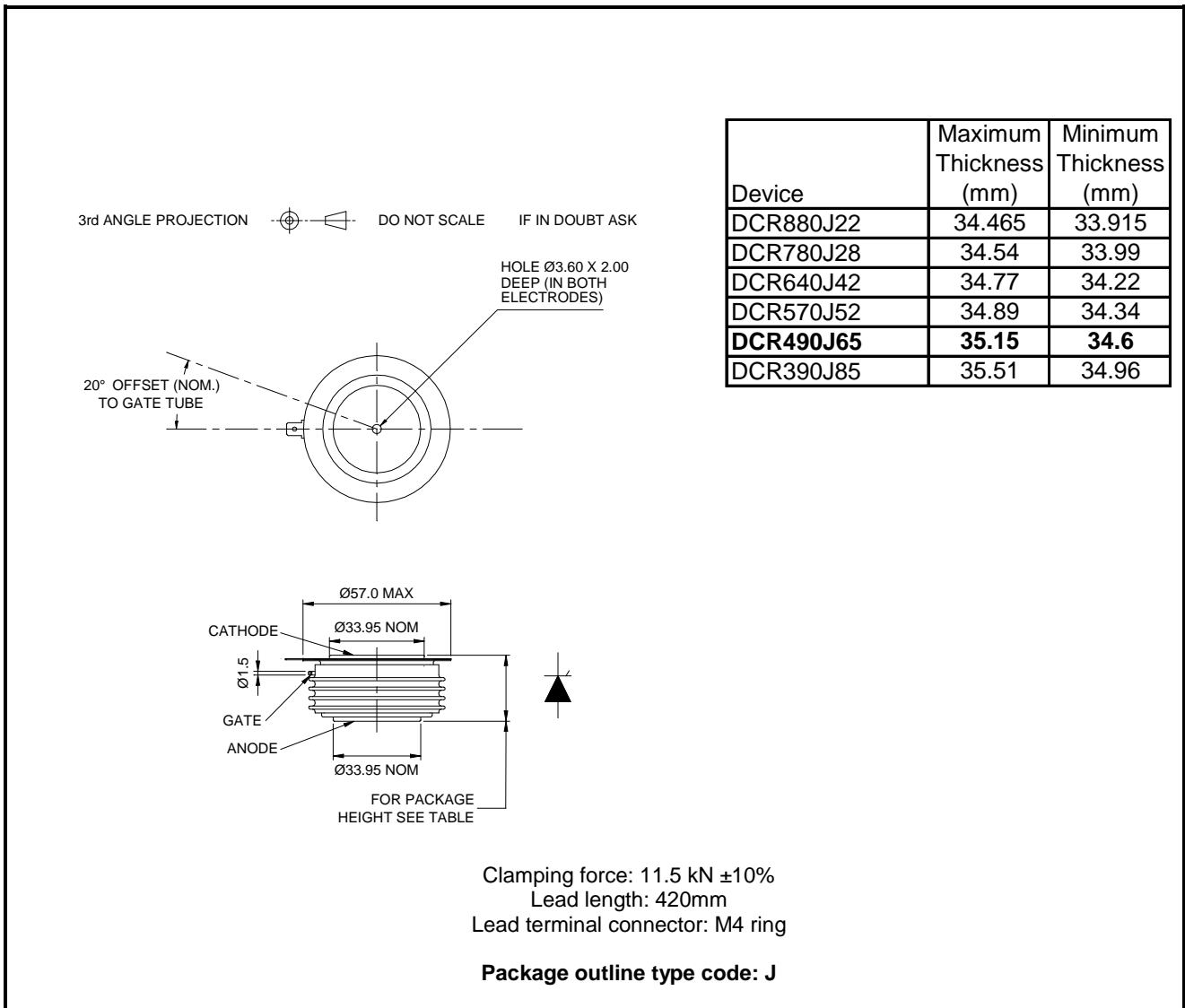

Fig.15 Package outline

POWER ASSEMBLY CAPABILITY

The Power Assembly group was set up to provide a support service for those customers requiring more than the basic semiconductor, and has developed a flexible range of heatsink and clamping systems in line with advances in device voltages and current capability of our semiconductors.

We offer an extensive range of air and liquid cooled assemblies covering the full range of circuit designs in general use today. The Assembly group offers high quality engineering support dedicated to designing new units to satisfy the growing needs of our customers.

Using the latest CAD methods our team of design and applications engineers aim to provide the Power Assembly Complete Solution (PACs).

HEATSINKS

The Power Assembly group has its own proprietary range of extruded aluminium heatsinks which have been designed to optimise the performance of Dynex semiconductors. Data with respect to air natural, forced air and liquid cooling (with flow rates) is available on request.

For further information on device clamps, heatsinks and assemblies, please contact your nearest sales representative or Customer Services.

Stresses above those listed in this data sheet may cause permanent damage to the device. In extreme conditions, as with all semiconductors, this may include potentially hazardous rupture of the package. Appropriate safety precautions should always be followed.



<http://www.dynexsemi.com>

e-mail: power_solutions@dynexsemi.com

**HEADQUARTERS OPERATIONS
DYNEX SEMICONDUCTOR LTD**
Doddington Road, Lincoln
Lincolnshire, LN6 3LF. United Kingdom.
Tel: +44(0)1522 500500
Fax: +44(0)1522 500550

CUSTOMER SERVICE
Tel: +44(0)1522 502753 / 502901. Fax: +44(0)1522 500020

© Dynex Semiconductor 2003 TECHNICAL DOCUMENTATION – NOT FOR RESALE. PRODUCED IN UNITED KINGDOM.

This publication is issued to provide information only which (unless agreed by the Company in writing) may not be used, applied or reproduced for any purpose nor form part of any order or contract nor to be regarded as a representation relating to the products or services concerned. No warranty or guarantee express or implied is made regarding the capability, performance or suitability of any product or service. The Company reserves the right to alter without prior notice the specification, design or price of any product or service. Information concerning possible methods of use is provided as a guide only and does not constitute any guarantee that such methods of use will be satisfactory in a specific piece of equipment. It is the user's responsibility to fully determine the performance and suitability of any equipment using such information and to ensure that any publication or data used is up to date and has not been superseded. These products are not suitable for use in any medical products whose failure to perform may result in significant injury or death to the user. All products and materials are sold and services provided subject to the Company's conditions of sale, which are available on request.

All brand names and product names used in this publication are trademarks, registered trademarks or trade names of their respective owners.